

BMI CANADA LEAD FREE BRASS BALL VALVES PRICE LIST



**BBV
18-1**

March 19, 2018 (b)

FULLPORT "SWEAT" BRASS BALL VALVES

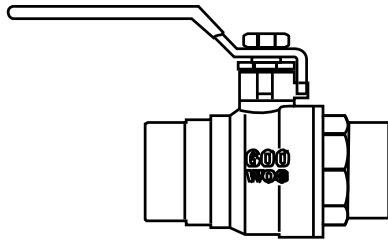

600CWP 150SWP				
BMI#	Size	Packing	Barcode	\$
13204	1/2	10/120	777701132049	22.62
13205	3/4	10/80	777701132056	37.21
13206	1	6/48	777701132063	62.78
13207	1 1/4	4/24	777701132070	88.60
13208	1 1/2	2/16	777701132087	139.40
13209	2	1/12	777701132094	211.65

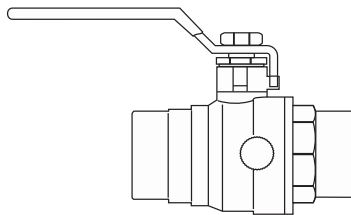

400CWP 100 SWP				
BMI#	Size	Packing	Barcode	\$
13210	2 1/2	1/1	777701132100	478.26
13211	3	1/1	777701132117	653.67
13212	4	1/1	777701132124	1 333.50

SOLDER END BALL VALVES WITH DRAIN				
BMI#	Size	Packing	Barcode	\$
13224	1/2	10/100	777701132247	31.74
13225	3/4	6/60	777701132254	48.31
13226	1	6/36	777701132261	69.55

FULLPORT COMPRESSION X COMPRESSION BALL VALVES

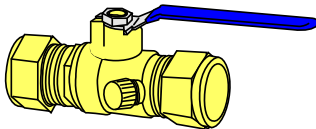
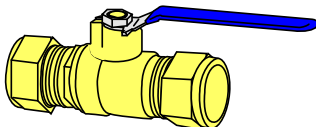

BMI#	Size	Packing	Barcode	\$
13554	1/2	6/36	777701135545	30.26
13555	3/4	10/100	777701135552	60.27
13556	1	10/60	777701135569	86.01

WITH DRAIN				
BMI#	Size	Packing	Barcode	\$
13564	1/2	10/100	777701135644	33.99
13565	3/4	10/100	777701135651	62.77

COLD EXPANSION BRASS BALL VALVES

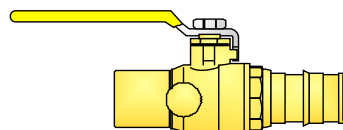
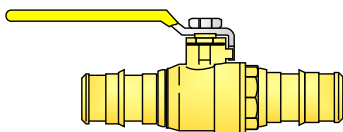

BMI#	Size	Packing	Barcode	\$
13854	1/2	10/100	777701138546	32.97
13855	3/4	10/100	777701138553	45.25
13856	1	5/100	777701138560	58.19
13857	1 1/4	5/50	777701138577	117.70
13858	1 1/2	5/50	777701138584	156.22
13859	2	5/25	777701138591	273.92

C X EXP. WITH DRAIN				
BMI#	Size	Packing	Barcode	\$
13874	1/2	10/100	777701138744	34.91
13875	3/4	10/100	777701138751	50.43



FULLPORT PRESS-FIT BRASS BALL VALVES

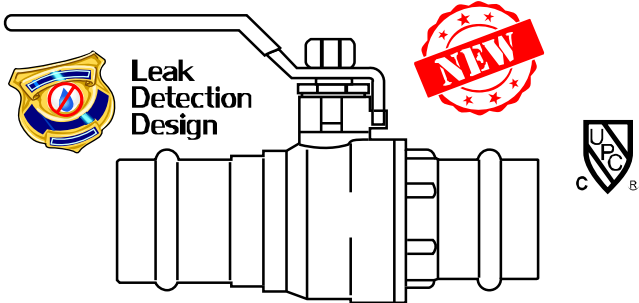

250PSI				
BMI#	Size	Packing	Barcode	\$
13514	1/2	10/50	777701135149	52.29
13515	3/4	10/30	777701135156	74.28
13516	1	5/20	777701135163	130.30
13517	1 1/4	4/12	777701135170	187.27
13518	1 1/2	3/6	777701135187	260.61
13519	2	2/6	777701135194	402.61
13520	2 1/2	1/4	777701135200	535.00
13521	3	1/3	777701135217	765.05
13522	4	1/2	777701135224	1 337.50

FULLPORT "THREADED" BRASS BALL VALVES

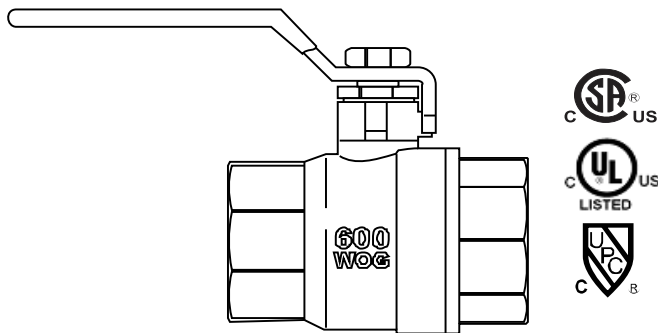

600CWP 150SWP				
BMI#	Size	Packing	Barcode	\$
13102	1/4	10/120	777701131028	18.21
13103	3/8	10/120	777701131035	18.46
13104	1/2	10/120	777701131042	25.89
13105	3/4	10/80	777701131059	38.63
13106	1	6/60	777701131066	59.72
13107	1 1/4	2/36	777701131073	87.60
13108	1 1/2	2/24	777701131080	130.09
13109	2	2/16	777701131097	195.06

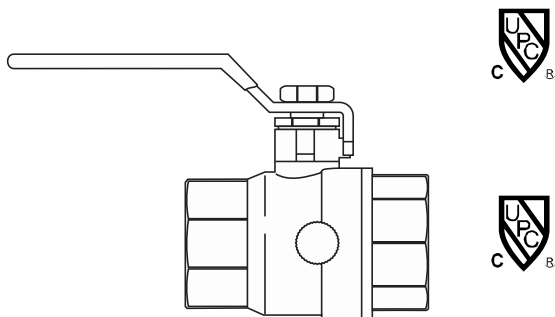

400CWP 100 SWP				
BMI#	Size	Packing	Barcode	\$
13110	2 1/2	2/4	777701131103	564.32
13111	3	1/1	777701131110	698.91
13112	4	1/1	777701131127	1 349.30

BALL VALVES WITH DRAIN				
BMI#	Size	Packing	Barcode	\$
13124	1/2	10/100	777701131240	35.58
13125	3/4	6/60	777701131257	54.09
13126	1	6/36	777701131264	76.86



PEX BRASS BALL VALVES

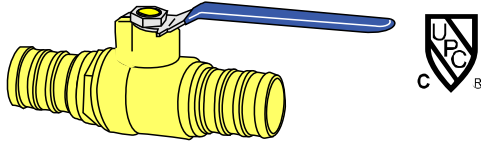

BLUE OR RED STRAIGHT HANDLES				
Blue	Red	Size	Packing	\$
13354	13454	1/2	10/100	19.63
13355	13455	3/4	10/100	26.54
13356	13456	1	6/60	44.50

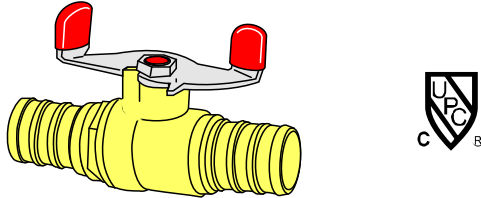

BLUE OR RED BUTTERFLY HANDLES				
Blue	Red	Size	Packing	\$
13364	13464	1/2	10/100	20.23
13365	13465	3/4	10/100	27.14
13366	13466	1	6/60	45.58

PEX BRASS BALL VALVES WITH DRAIN

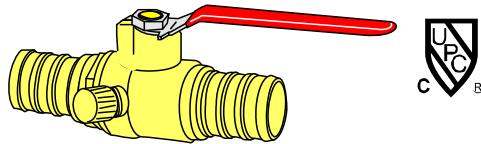

BLUE OR RED STRAIGHT HANDLES				
Blue	Red	Size	Packing	\$
13374	13474	1/2	10/100	22.15
13375	13475	3/4	10/100	29.63
13376	13476	1	6/60	49.49

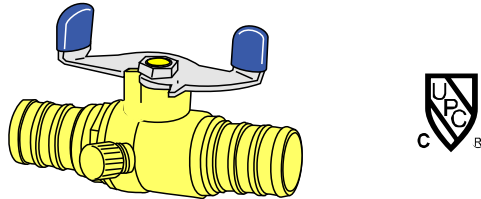

BLUE OR RED BUTTERFLY HANDLES				
Blue	Red	Size	Packing	\$
13384	13484	1/2	10/100	22.73
13385	13485	3/4	10/100	30.22
13386	13486	1	5/100	50.70

PEX x C BRASS BALL VALVES

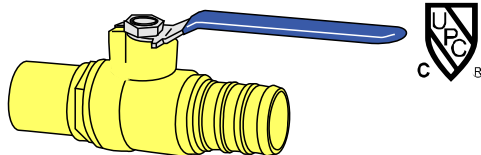

BMI#	Size	Packing	Barcode	\$
13324	1/2	10/100	777701133244	21.10
13325	3/4	10/100	777701133251	28.62

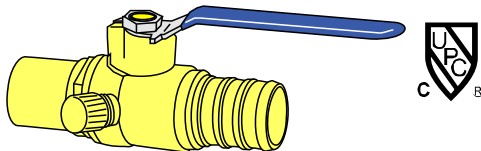

PEX x C BRASS BALL VALVES WITH DRAIN/COP				
BMI#	Size	Packing	Barcode	\$
13334	1/2	10/100	777701133343	27.89
13335	3/4	10/100	777701133350	34.66
13336	1	10/100	777701133367	47.95

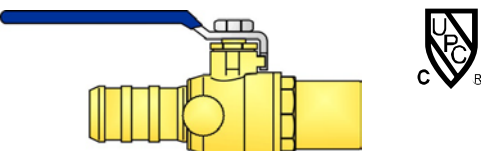

PEX x C BRASS BALL VALVES WITH DRAIN/PEX				
BMI#	Size	Packing	Barcode	\$
13344	1/2	10/100	777701133442	27.89
13345	3/4	10/100	777701133459	34.66
13346	1	10/100	777701133466	47.95



HANDLES AND STEM EXTENSIONS FOR BALL VALVES

These items are sold in multiples of inner pack quantities only. Minimum quantity is equal to one inner pack.

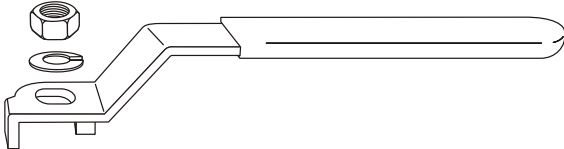

STAINLESS STEEL HANDLES					
BMI#	Size	Min. Qty	Packing	Barcode	\$
13001	1/4" to 1/2"	5	5/50	777701130014	4.35
13002	3/4" to 1"	5	5/30	777701130021	7.85
13003	1 1/4" to 2"	2	2/20	777701130038	13.05

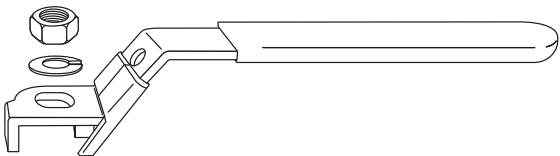

STAINLESS STEEL LOCK HANDLES					
BMI#	Size	Min. Qty	Packing	Barcode	\$
13007	1/4" to 1/2"	5	5/50	777701130076	6.15
13008	3/4" to 1"	5	5/30	777701130083	10.50
13009	1 1/4" to 2"	2	2/20	777701130090	13.95

STEEL LOCK HANDLES					
BMI#	Size	Min. Qty	Packing	Barcode	\$
13004	1/4" to 1/2"	5	5/50	777701130045	4.90
13005	3/4" to 1"	5	5/30	777701130052	5.25
13006	1 1/4" to 2"	2	2/20	777701130069	6.15

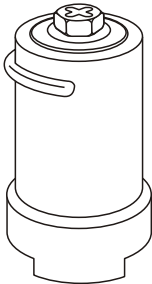

BRASS STEM EXTENSIONS					
BMI#	Size	Min. Qty	Packing	Barcode	\$
13010	1/4" to 1/2"	5	5/50	777701130106	20.05
13011	3/4" to 1"	5	5/30	777701130113	28.75
13012	1 1/4" to 2"	2	2/20	777701130120	35.00

NOT SUITABLE FOR POTABLE WATER

FULLPORT THREADED BRASS BALL VALVES (REGULAR)

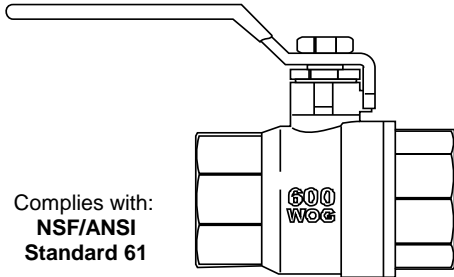

Complies with:
NSF/ANSI
Standard 61



600CWP 150SWP				
BMI#	Size	Packing	Barcode	\$
13802	1/4	10/120	777701138027	13.79
13803	3/8	10/120	777701138034	13.79
13804	1/2	10/120	777701138041	19.25
13805	3/4	10/80	777701138058	28.52
13806	1	6/60	777701138065	44.27
13807	1 1/4	2/36	777701138072	64.86
13808	1 1/2	2/24	777701138089	101.23
13809	2	2/16	777701138096	143.98

Complies with:
NSF/ANSI
Standard 61



400CWP 100 SWP				
BMI#	Size	Packing	Barcode	\$
13810	2 1/2	2/4	777701138102	324.37
13811	3	1/4	777701138119	486.18
13812	4	1/2	777701138126	771.88

LEVER HANDLE APPLIANCE GAS BALL VALVES

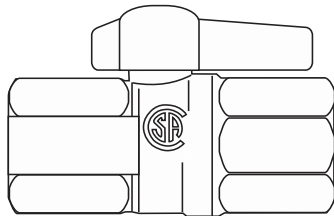

WITH LEVER HANDLE



YELLOW OR RED LEVER HANDLE				
YELLOW	RED	Size	Packing	\$
13404	13504	1/2	10/100	15.04
13405	13505	3/4	10/100	19.83
13406	13506	1	6/60	34.66