

**LISTE DE PRIX BMI CANADA
ROBINETS ANTIGEL**

**FFF
18-1**

19 mars 2018 (b)

NON CONÇU POUR L'EAU POTABLE

ROBINETS ANTIGEL QUART DE TOUR

COP ou MIPS x 1/2"				
#BMI	Taille	Emballage	Code à barres	\$
27004	4	1/25	777701270048	83.83
27006	6	1/25	777701270062	86.77
27008	8	1/25	777701270086	89.81
27010	10	1/25	777701270109	92.86
27012	12	1/25	777701270123	96.01
27014	14	1/25	777701270147	99.06
27018	18	1/25	777701270185	108.15

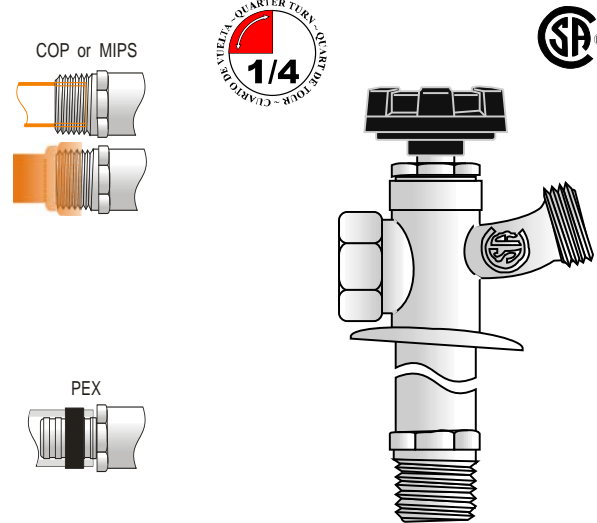

PEX x 1/2"				
#BMI	Taille	Emballage	Code à barres	\$
27204	4	1/25	777701272042	83.83
27206	6	1/25	777701272066	86.77
27208	8	1/25	777701272080	89.81
27210	10	1/25	777701272103	92.86
27212	12	1/25	777701272127	96.01
27214	14	1/25	777701272141	99.06
27218	18	1/25	777701272189	108.15

ROBINETS ANTIGEL ULTRA

COP ou MIPS x 1/2"				
#BMI	Taille	Emballage	Code à barres	\$
27404	4	1/25	777701274046	61.87
27406	6	1/25	777701274060	64.69
27408	8	1/25	777701274084	67.40
27410	10	1/25	777701274107	70.20
27412	12	1/25	777701274121	73.01
27414	14	1/25	777701274145	75.79
27418	18	1/25	777701274183	84.12

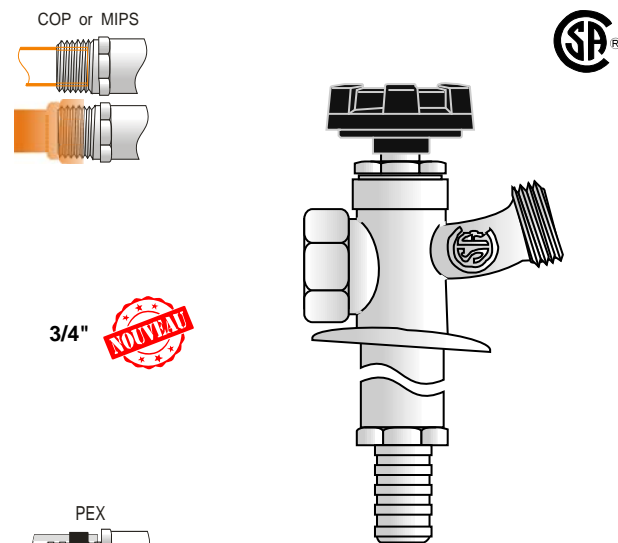

27432	12 x 3/4"	1/25	777701274329	73.50
-------	-----------	------	--------------	-------

PEX x 1/2"				
#BMI	Taille	Emballage	Code à barres	\$
27504	4	1/25	777701275043	61.87
27506	6	1/25	777701275067	64.69
27508	8	1/25	777701275081	67.40
27510	10	1/25	777701275104	70.20
27512	12	1/25	777701275128	73.01
27514	14	1/25	777701275142	75.79
27518	18	1/25	777701275180	84.12

EXPANSION À FROID x 1/2"				
#BMI	Taille	Emballage	Code à barres	\$
27818	8	1/25	777701278181	90.30
27820	10	1/25	777701278204	94.05
27822	12	1/25	777701278228	97.88
27824	14	1/25	777701278242	101.55

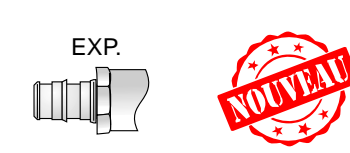

NON CONÇU POUR L'EAU POTABLE

ROBINETS ANTIGEL CHAUD ET FROID

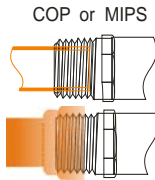

COP ou MIPS x 1/2"				
#BMI	Taille	Emballage	Code à barres	\$
27804	4	1/10	777701278044	243.48
27806	6	1/10	777701278068	269.34
27808	8	1/10	777701278082	292.16
27810	10	1/10	777701278105	315.92
27812	12	1/10	777701278129	334.17
27814	14	1/10	777701278143	359.73

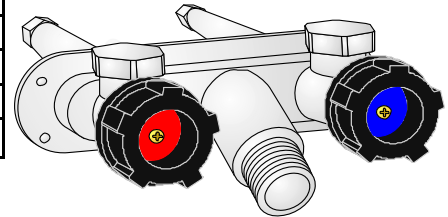

ENSEMBLE DE TIGE POUR ROBINETS CHAUD & FROID

#BMI	Taille	Emballage	Code à barres	\$
27924	4	1/25	777701279249	24.61
27926	6	1/25	777701279263	25.81
27928	8	1/25	777701279287	29.89
27930	10	1/25	777701279300	31.34
27932	12	1/25	777701279324	33.31
27934	14	1/25	777701279348	34.79

ENSEMBLE DE BRISE-VIDE

#BMI	Emballage	Code à barres	\$
27883	1/50	777701278839	6.91

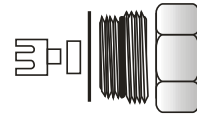

ENSEMBLE DE POIGNÉE EN ALUMINIUM et ABS

#BMI	Emballage	Code à barres	\$
27884	25/100	777701278846	7.71



NON CONÇU POUR L'EAU POTABLE**PIÈCES POUR ROBINETS ANTIGEL QUART DE TOUR****ENSEMBLE DE TIGE**

#BMI	Taille	Emballage	Code à barres	\$
27604	4	1/25	777701276040	35.21
27606	6	1/25	777701276064	36.90
27608	8	1/25	777701276088	38.86
27610	10	1/25	777701276101	40.76
27612	12	1/25	777701276125	43.32
27614	14	1/25	777701276149	45.23
27618	18	1/25	777701276187	58.23

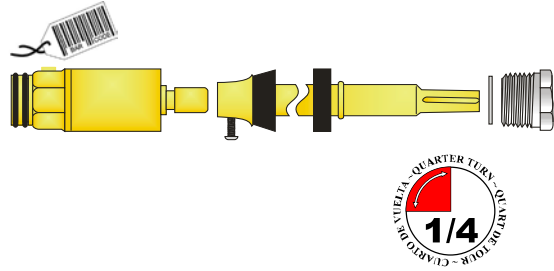
**ENSEMBLE DE BRISE-VIDE**

#BMI	Emballage	Code à barres	\$
27883	1/50	777701278839	6.91

**ENSEMBLE DE POIGNÉE EN ALUMINIUM et ABS**

#BMI	Emballage	Code à barres	\$
27884	25/100	777701278846	7.71

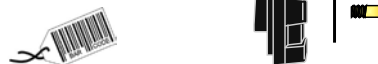
**PIÈCES POUR ROBINETS ANTIGEL ULTRA****ENSEMBLE DE TIGE**

#BMI	#BMI	Taille	Emballage	Code à barres	\$
ULTRA	ULTRA 'A'				
27708	27728	8	1/25	777701277085	29.89
27710	27730	10	1/25	777701277108	31.34
27712	27732	12	1/25	777701277122	33.31
27714	27734	14	1/25	777701277146	34.79
27718	27738	18	1/25	777701277184	44.81

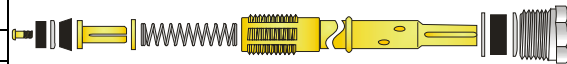
**ENSEMBLE DE BRISE-VIDE**

#BMI	Emballage	Code à barres	\$
27883	1/50	777701278839	6.91

**ENSEMBLE DE POIGNÉE EN ALUMINIUM et ABS**

#BMI	Emballage	Code à barres	\$
27884	25/100	777701278846	7.71

**PIÈCES POUR ROBINETS ANTIGEL INDONÉSIE****ENSEMBLE DE TIGE**

#BMI	Taille	Emballage	Code à barres	\$
27908	8	1/25	777701279089	25.78
27910	10	1/25	777701279102	27.03
27912	12	1/25	777701279126	28.71
27914	14	1/25	777701279140	29.99
27918	18	1/25	777701279188	38.60

