

# BRASS PUSH-FIT FITTINGS

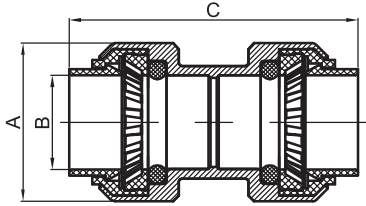

COUPLINGS				
BMI#	Size	A	B	C
38004	1/2	27	16.1	50
38005	3/4	34.2	22.35	58
38006	1	42.2	28.8	65
38023	3/4 x 1/2	34.2	22.35	58
38027	1 x 3/4	42.2	28.8	65

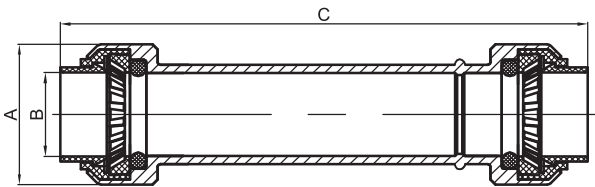

REPAIR COUPLINGS				
BMI#	Size	A	B	C
38014	1/2	27	16.1	105
38015	3/4	34.2	22.35	105
38016	1	42.2	28.8	105

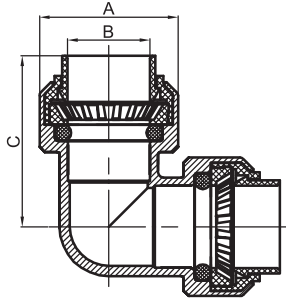

90° ELBOWS				
BMI#	Size	A	B	C
38304	1/2	27	16.1	34
38305	3/4	34.2	22.35	41
38306	1	42.2	28.8	48
38323	3/4 x 1/2	34.2	22.35	48

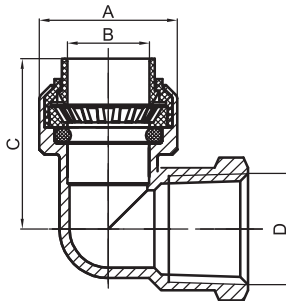

P.F. x FIPS 90° ELBOWS					
BMI#	Size	A	B	C	D
38384	1/2	27	16.1	35	1/2 NPT
38385	3/4	34.2	22.35	40	3/4 NPT
38386	1	42.2	28.8	48	1 NPT

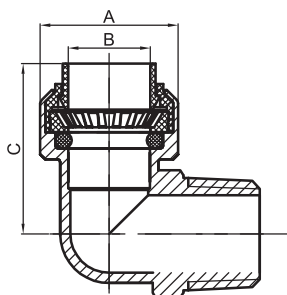

P.F. x MIPS 90° ELBOWS					
BMI#	Size	A	B	C	D
38364	1/2	27	16.1	35	1/2 NPT
38365	3/4	34.2	22.35	40	3/4 NPT
38366	1	42.2	28.8	48	1 NPT

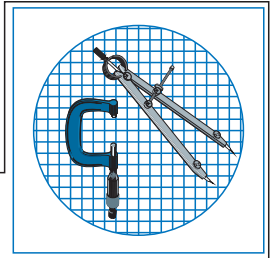

# BRASS PUSH-FIT FITTINGS

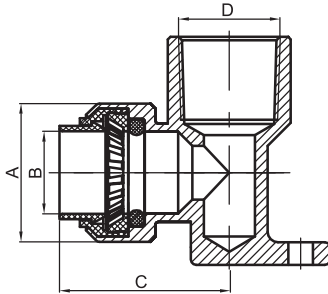

**P.F. x FIPS 90° ELBOWS WITH DROPEARS**

BMI#	Size	A	B	C	D
38399	1/2	27	16.1	33	1/2 NPT

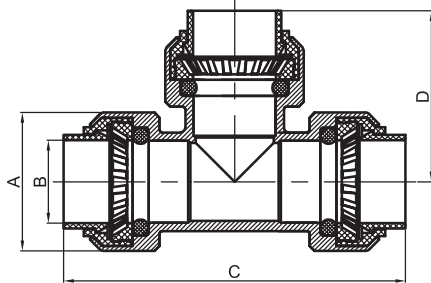

**TEES**

BMI#	Size	A	B	C	D
38404	1/2	27	16.1	67	34
38405	3/4	34.2	22.35	80	41
38406	1	42.2	28.8	96	48
38429	3/4 x 3/4 x 1/2	34.2	22.35	74	41
38430	3/4 x 1/2 x 3/4	34.2	22.35	84	42
38431	3/4 x 1/2 x 1/2	34.2	22.35	72	38
38438	1 x 1 x 3/4	42.2	28.8	85	85

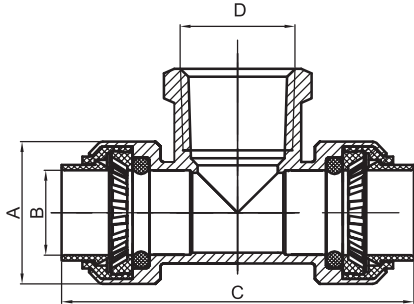

**P.F. x P.F. x FIPS**

BMI#	Size	A	B	C	D
38591	1/2	27	16.1	68	1/2 NPT
38592	3/4	34.2	22.35	80	3/4 NPT

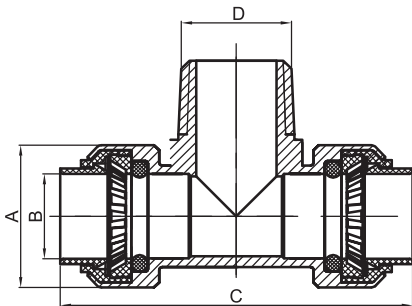

**P.F. x P.F. x MIPS**

BMI#	Size	A	B	C	D
38574	1/2	27	16.1	68	1/2 NPT
38575	3/4	34.2	22.35	80	3/4 NPT

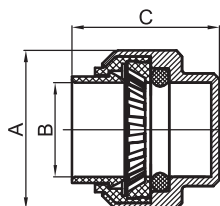

**CAPS**

BMI#	Size	A	B	C
38504	1/2	27	16.1	27
38505	3/4	34.2	22.35	31
38506	1	42.2	28.8	38

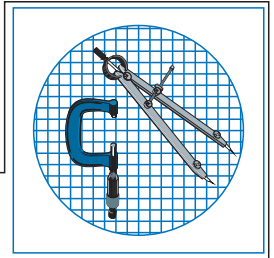

# BRASS PUSH-FIT FITTINGS

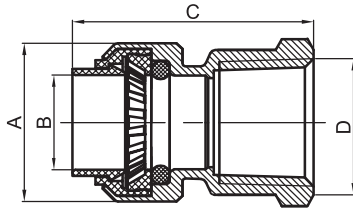

P.F. x FIPS ADAPTERS					
BMI#	Size	A	B	C	D
38704	1/2	27	16.1	41.2	1/2 NPT
38705	3/4	34.2	22.35	46.9	3/4 NPT
38706	1	42.2	28.8	53.6	1 NPT
38723	1/2 x 3/4	27	16.1	42.2	3/4 NPT

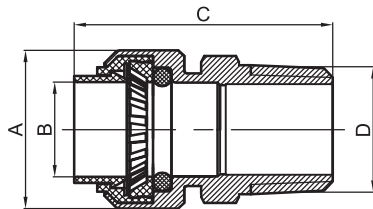

P.F. x MIPS ADAPTERS					
BMI#	Size	A	B	C	D
38804	1/2	27	16.1	44	1/2 NPT
38805	3/4	34.2	22.35	49	3/4 NPT
38806	1	42.2	28.8	50.5	1 NPT
38817	1/2 x 3/4	27	16.1	45	3/4 NPT

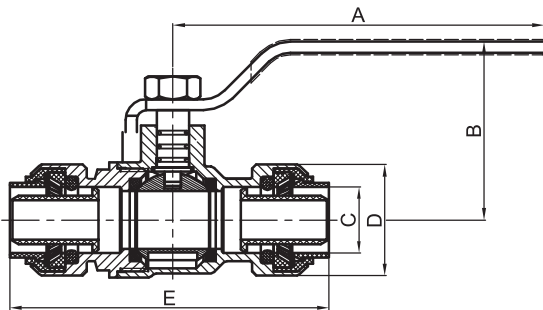

BALL VALVES						
BMI#	Size	A	B	C	D	E
38604	1/2	92.5	43	16.1	27	75
38605	3/4	92.5	46.5	22.35	34.2	91
38606	1	106	61.5	28.8	42.2	110.5

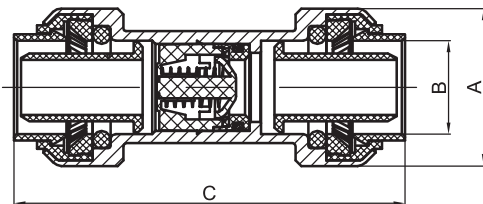

SPRING LOAD CHECK VALVES				
BMI#	Size	A	B	C
38654	1/2	27	16.1	70
38655	3/4	34.2	22.35	85
38656	1	42.2	28.8	105

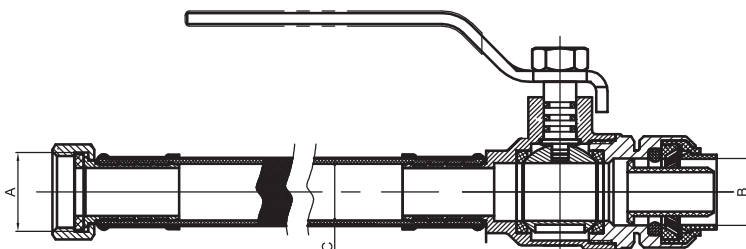

P.F. x FIPS (SWVL) FLEXIBLE TUBES & VALVES				
BMI#	Size	A	B	C
38632	1/2 x 3/4 x 12	3/4 NPT	16.1	17
38635	1/2 x 3/4 x 15	3/4 NPT	16.1	17
38638	1/2 x 3/4 x 18	3/4 NPT	16.1	17
38644	1/2 x 3/4 x 24	3/4 NPT	16.1	17
38612	3/4 x 12	3/4 NPT	22.35	26
38615	3/4 x 15	3/4 NPT	22.35	26
38618	3/4 x 18	3/4 NPT	22.35	26
38624	3/4 x 24	3/4 NPT	22.35	26

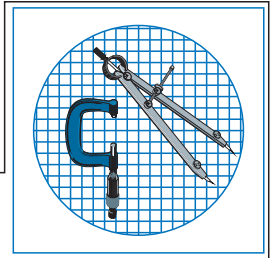

# BRASS PUSH-FIT FITTINGS

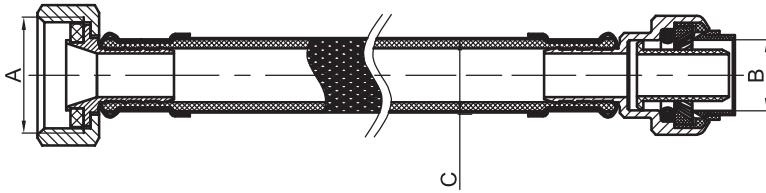

P.F. x FIPS (SWVL) FLEXIBLE TUBES				
BMI#	Size	A	B	C
38212	3/4 x 12	3/4 NPT	22.35	26
38215	3/4 x 15	3/4 NPT	22.35	26
38218	3/4 x 18	3/4 NPT	22.35	26
38224	3/4 x 24	3/4 NPT	22.35	26

**Performance:**

- Max. Pressure . . . . . 200 psi / 1378 kPa
- Max. Temperature . . . 180 °F / 82 °C (water)
- Opening . . . . . Full fluid flow (without stiffener inserts)
- Service . . . . . Domestic & commercial
- Water . . . . . Potable water, distribution systems & hydronic heating systems
- Interior installation . . . With or without an access panel
- Exterior installation . . . Above or underground (protected)

**Glossary:**

- EPDM . . . . . Ethylene propylene diene monomer
- PTFE . . . . . Polytetrafluoroethylene
- POM . . . . . Polyoxymethylene
- PSU . . . . . Polysulfone
- SUS 304 . . . . . Stainless steel #304

**Metal alloy:**

- C46500 . . . . . Cu = 59~62%, Pb = <0.2%, Sn = 0.5~1%, Zn = rem.

LIST OF MATERIALS		
	Part	Material
1	Handle Nut	SUS 304
2	Handle	Q235 Steel
3	'O' Ring	EPDM
4	Stem	Brass C46500
5	Stiffener	PSU
6	Seat Ring	POM
7	Push Ring	POM
8	Gripper Ring	SUS 304
9	Lock Ring	POM
10	'O' Ring	EPDM
11	Bonnet	Brass C46500
12	Ball Seat	PTFE
13	Ball	Brass C46500
14	Body	Brass C46500

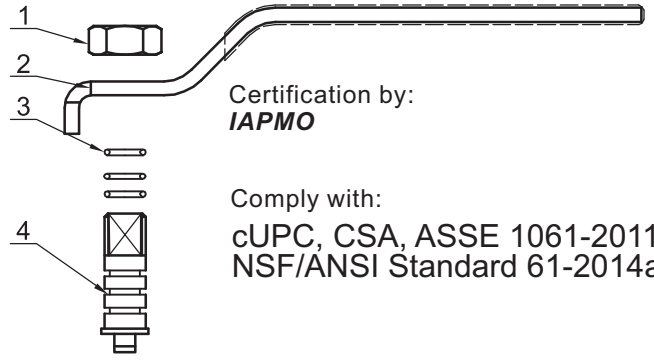
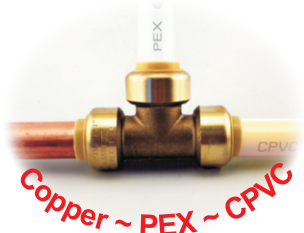

Certification by:  
**IAPMO**

Comply with:  
cUPC, CSA, ASSE 1061-2011  
NSF/ANSI Standard 61-2014a

