

BMI CANADA FROST FREE FAUCETS PRICE LIST

**FFF
22-1**

February 21, 2022

NOT SUITABLE FOR POTABLE WATER

BMI QUARTER TURN FROST FREE FAUCETS

COP or MIPS x 1/2"				
BMI#	Size	Packing	Barcode	\$
27004	4	1/25	777701270048	115.26
27006	6	1/25	777701270062	119.30
27008	8	1/25	777701270086	123.48
27010	10	1/25	777701270109	127.68
27012	12	1/25	777701270123	132.01
27014	14	1/25	777701270147	136.19
27018	18	1/25	777701270185	148.70

PEX x 1/2"				
BMI#	Size	Packing	Barcode	\$
27204	4	1/25	777701272042	115.26
27206	6	1/25	777701272066	119.30
27208	8	1/25	777701272080	123.48
27210	10	1/25	777701272103	127.68
27212	12	1/25	777701272127	132.01
27214	14	1/25	777701272141	136.19
27218	18	1/25	777701272189	148.70

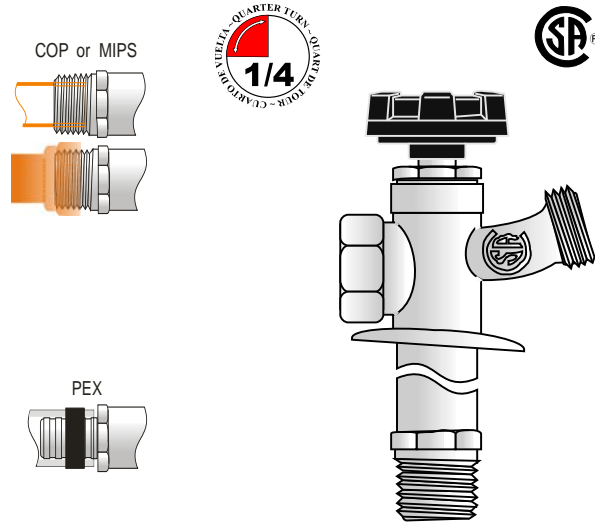

BMI ULTRA FROST FREE FAUCETS

COP or MIPS x 1/2"				
BMI#	Size	Packing	Barcode	\$
27404	4	1/25	777701274046	85.07
27406	6	1/25	777701274060	88.92
27408	8	1/25	777701274084	92.67
27410	10	1/25	777701274107	96.52
27412	12	1/25	777701274121	100.38
27414	14	1/25	777701274145	104.21
27418	18	1/25	777701274183	115.67

27432	12 x 3/4"	1/25	777701274329	101.06
-------	-----------	------	--------------	--------

PEX x 1/2"				
BMI#	Size	Packing	Barcode	\$
27504	4	1/25	777701275043	85.07
27506	6	1/25	777701275067	88.92
27508	8	1/25	777701275081	92.67
27510	10	1/25	777701275104	96.52
27512	12	1/25	777701275128	100.38
27514	14	1/25	777701275142	104.21
27518	18	1/25	777701275180	115.67

COLD EXPANSION x 1/2"				
BMI#	Size	Packing	Barcode	\$
27818	8	1/25	777701278181	124.16
27820	10	1/25	777701278204	129.30
27822	12	1/25	777701278228	134.57
27824	14	1/25	777701278242	139.62

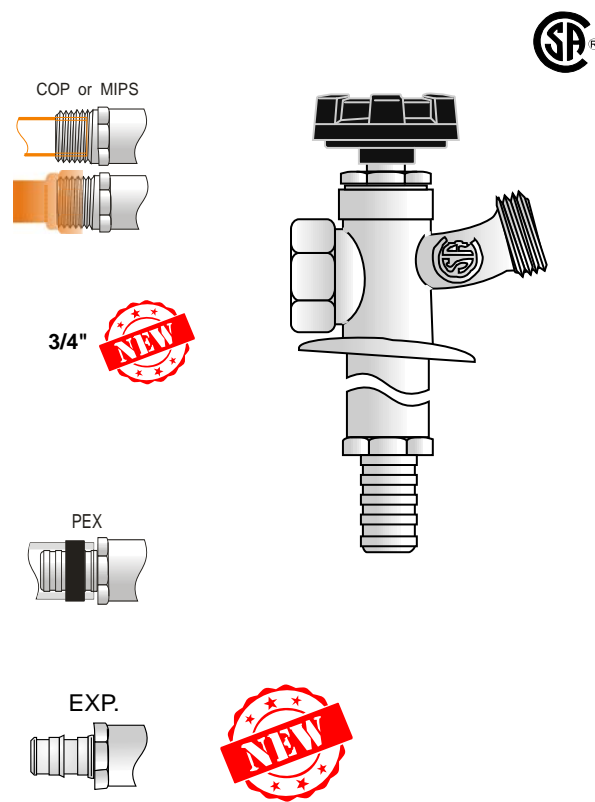

NOT SUITABLE FOR POTABLE WATER

BMI HOT & COLD FROST FREE FAUCETS

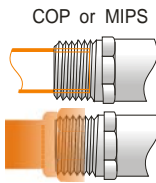

COP or MIPS x 1/2"				
BMI#	Size	Packing	Barcode	\$
27804	4	1/10	777701278044	334.77
27806	6	1/10	777701278068	370.32
27808	8	1/10	777701278082	401.69
27810	10	1/10	777701278105	434.37
27812	12	1/10	777701278129	459.45
27814	14	1/10	777701278143	494.60

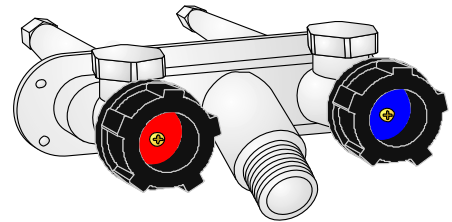

HOT & COLD STEM ASSEMBLY REPLACEMENT KITS

BMI#	Size	Packing	Barcode	\$
27924	4	1/25	777701279249	33.83
27926	6	1/25	777701279263	35.49
27928	8	1/25	777701279287	41.10
27930	10	1/25	777701279300	43.09
27932	12	1/25	777701279324	45.80
27934	14	1/25	777701279348	47.83

VACUUM BREAKER REPLACEMENT KITS

BMI#	Packing	Barcode	\$
27883	1/50	777701278839	9.51

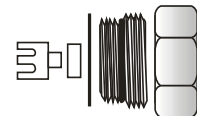

ALUMINUM with ABS COATING HANDLE REPLACEMENT KITS

BMI#	Packing	Barcode	\$
27884	25/100	777701278846	10.61



NOT SUITABLE FOR POTABLE WATER

PARTS FOR QUARTER TURN FAUCETS

STEM ASSEMBLY REPLACEMENT KITS

BMI#	Size	Packing	Barcode	\$
27604	4	1/25	777701276040	48.42
27606	6	1/25	777701276064	50.74
27608	8	1/25	777701276088	53.42
27610	10	1/25	777701276101	56.05
27612	12	1/25	777701276125	59.56
27614	14	1/25	777701276149	62.18
27618	18	1/25	777701276187	80.06

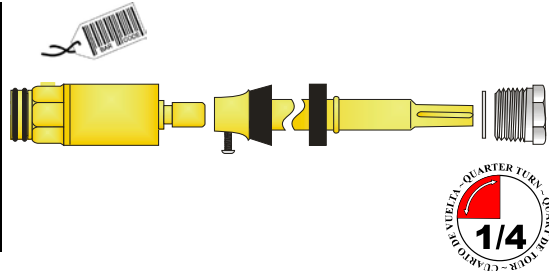

VACUUM BREAKER REPLACEMENT KITS

BMI#	Packing	Barcode	\$
27883	1/50	777701278839	9.51

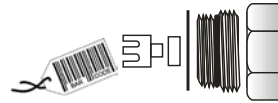

ALUMINUM with ABS COATING HANDLE REPLACEMENT KITS

BMI#	Packing	Barcode	\$
27884	25/100	777701278846	10.61



PARTS FOR ULTRA FAUCETS

STEM ASSEMBLY REPLACEMENT KITS

BMI#	BMI#	Size	Packing	Barcode	\$
27704	-	4	1/25	777701277047	33.83
27706	27726	6	1/25	777701277061	35.49
27708	27728	8	1/25	777701277085	41.10
27710	27730	10	1/25	777701277108	43.09
27712	27732	12	1/25	777701277122	45.80
27714	27734	14	1/25	777701277146	47.83
27718	27738	18	1/25	777701277184	61.60

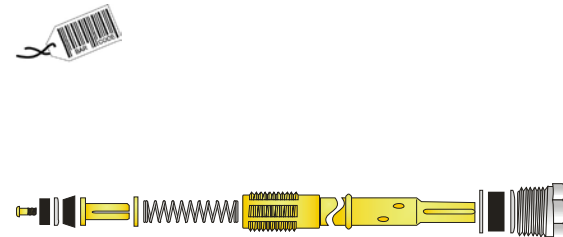

VACUUM BREAKER REPLACEMENT KITS

BMI#	Packing	Barcode	\$
27883	1/50	777701278839	9.51



ALUMINUM with ABS COATING HANDLE REPLACEMENT KITS

BMI#	Packing	Barcode	\$
27884	25/100	777701278846	10.61



PARTS FOR INDONESIA FAUCETS

STEM ASSEMBLY REPLACEMENT KIT

BMI#	Size	Packing	Barcode	\$
27908	8	25/100	777701279089	35.45
27910	10	25/100	777701279102	37.17
27912	12	25/100	777701279126	39.48
27914	14	25/100	777701279140	41.22
27918	18	25/100	777701279188	53.08

