

Catalogue de pièces BMI
Table des matières

	Nom de liste	Date de liste	Cat #	Page #
Laiton				
Raccords de laiton taraudés 125 - sans plomb	BLF-26-1	2026-03-09	06	1
Tuyaux & mamelons de laiton taraudés - sans plomb	BPN-26-1	2026-03-09	04	7
Tuyaux & mamelons de laiton taraudés	BPN-26-1	2026-03-09	24	9
Valves en laiton				
Valves à bille en laiton - sans plomb	BBVLS-26-1	2026-03-09	13	11
Valves en laiton	BRV-26-1	2026-03-09	14	17
Valves en laiton – sans plomb	BRVLS-26-1	2026-03-09	14	19
Robinets antigel plaqués chrome	FFF-26-1	2026-03-09	27	21
Raccords cuivre				
Raccords en cuivre ouvré "BMI Press-Fit"	CPF-26-1	2026-03-09	47	25
Raccords cuivrés coulés - type pression - sans plomb	CCFLS-26-1	2026-03-09	25	29
Raccords en cuivre DWV	DWV-26-1	2026-03-09	22	33
Raccords cuivrés ouvrés type pression	CWR-26-1	2026-03-09	37	37
Raccords de cuivre ACR - réfrigération	ACR-26-1	2026-03-09	37	43
Raccords de cuivre ACP Plus - réfrigération	ACRP-26-1	2026-03-09	43	49
Plomberie générale				
Unions diélectriques - sans plomb	DIELS-25-1	2025-03-12	07	53
Ruban-T (P.T.F.E.)	TEF-26-1	2026-03-09	28	55
Plomberie générale	GSP-25-1	2025-03-12	08	59
Valves à bille et adaptateurs chromés sans plomb	CPVLS-26-1	2026-03-09	09	61
Antibéliers - sans plomb	WHALS-26-1	2026-03-09	31	65
Manchons J.M.	NHC-25-1	2025-03-12	18	69
Raccords «Carbon Press»				
Raccords «BMI Carbon Press» EPDM	CPS-25-1	2025-03-12	45	71
Raccords «BMI Carbon Press» Gaz HNBR	CPSG-26-1	2026-02-09	46	73
Valves à bille Press en acier/laiton	CBV-26-1	2026-03-09	49	77
Valves à bille Press en acier au carbone	CBV-26-1	2026-03-09	60	77
Malléable				
Raccords en fonte malléable 150	MAC-25-1	2025-03-12	35	79
Raccords en fonte malléable 150 galvanisé	MAC-25-1	2025-03-12	36	79
Raccords en fonte malléable extralourd 300	MAX-25-1	2025-03-12	20	85
Brides compagnon en fonte et fonte ductile	CFL-25-1	2025-03-12	16	89
Raccords PEX et F1960				
Raccords poly-alliage expansion à froid – F1960	CXP-25-1	2025-03-12	42	91
Raccords en laiton expansion à froid – F1960	CXB-26-1	2026-03-09	44	95
Raccords PEX poly-alliage	PPX-25-1	2025-03-12	30	97
Raccords PEX - sans plomb	PEXLS-26-1	2026-03-09	39	99
Raccords Push-Fit				
Raccords "Push-Fit" - sans plomb	PFTLS-26-1	2026-03-09	38	103
Mamelons d'acier				
Manchons en acier ouvré	MER-25-1	2025-03-12	41	105
Mamelons tuyau d'acier standard	STN-25-1	2022-03-12	10	107
Mamelons tuyau d'acier standard galvanisé	STN-25-1	2022-03-12	11	108
Mamelons tuyau d'acier extralourd sans soudure	STX-25-1	2022-03-12	12	113
Information				
Politique de retour				115



LISTE DE PRIX BMI CANADA RACCORDS EN
LAITON (BRONZE) SANS PLOMB



**BLF
26-1**

9 mars 2026

LISTE BLF 26-1
9 mars 2026



ISO 9001
ISO 14001



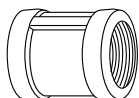

MANCHONS			
#BMI	Taille	Emballage	\$
06001	1/8	80/480	76.50
06002	1/4	80/480	76.50
06003	3/8	40/240	76.50
06004	1/2	25/150	98.05
06005	3/4	30/90	134.66
06006	1	15/60	226.13
06007	1 1/4	1/45	327.34
06008	1 1/2	1/35	426.02
06009	2	1/20	704.10
06010	2 1/2	8/16	1 325.54
06011	3	1/12	2 192.63
06012	4	3/6	4 533.10

MANCHONS RÉDUITS			
1/4", 3/8", 1/2"			
06015	1/4 x 1/8	100/600	90.72
06016	3/8 x 1/4	60/360	90.72
06017	3/8 x 1/8	60/360	90.72
06019	1/2 x 3/8	50/200	98.63
06020	1/2 x 1/4	50/200	98.63
06021	1/2 x 1/8	50/200	131.71
3/4"			
06023	3/4 x 1/2	25/100	155.66
06024	3/4 x 3/8	25/100	161.65
06025	3/4 x 1/4	25/100	180.61
1"			
06027	1 x 3/4	25/75	283.13
06028	1 x 1/2	25/75	283.13
06029	1 x 3/8	20/80	283.13
06030	1 x 1/4	25/100	283.13
1 1/4"			
06031	1 1/4 x 1	15/45	426.96
06032	1 1/4 x 3/4	15/45	426.96
06033	1 1/4 x 1/2	20/60	474.24
1 1/2"			
06035	1 1/2 x 1 1/4	1/40	540.98
06036	1 1/2 x 1	1/40	540.98
06037	1 1/2 x 3/4	1/45	586.94
06038	1 1/2 x 1/2	1/50	586.94
2"			
06040	2 x 1 1/2	1/10	836.26
06041	2 x 1 1/4	1/20	836.26
06042	2 x 1	1/20	883.40
06043	2 x 3/4	1/30	883.40
06044	2 x 1/2	1/30	883.40
2 1/2"			
06046	2 1/2 x 2	7/14	1 627.26

MANCHONS RÉDUITS			
#BMI	Taille	Emballage	\$
3"			
06052	3 x 2	5/10	2 855.52
06051	3 x 2 1/2	5/10	2 855.52
4"			
06058	4 x 2	3/6	6 945.00

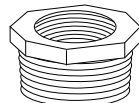

RÉDUCTEURS HEXAGONAUX			
1/4", 3/8"			
06115	1/4 X 1/8	200/1200	60.61
06116	3/8 X 1/4	120/720	60.61
06117	3/8 X 1/8	120/720	60.61
1/2"			
06119	1/2 X 3/8	80/480	65.70
06120	1/2 X 1/4	80/480	65.70
06121	1/2 X 1/8	80/480	85.42
3/4"			
06123	3/4 X 1/2	40/240	82.69
06124	3/4 X 3/8	40/240	82.69
06125	3/4 X 1/4	40/240	114.77
06126	3/4 X 1/8	40/240	119.93
1"			
06127	1 x 3/4	40/160	132.31
06128	1 x 1/2	40/160	132.31
06129	1 x 3/8	40/160	164.52
06130	1 x 1/4	40/160	171.44
1 1/4"			
06131	1 1/4 x 1	20/80	221.94
06132	1 1/4 x 3/4	20/80	221.94
06133	1 1/4 x 1/2	30/90	279.22
06134	1 1/4 x 3/8	5/80	321.06
06170	1 1/4 x 1/4	30/90	290.63
1 1/2"			
06135	1 1/2 x 1 1/4	15/60	279.41
06136	1 1/2 x 1	15/60	279.41
06137	1 1/2 x 3/4	25/75	360.06
06138	1 1/2 x 1/2	25/75	374.88
06180	1 1/2 x 1/4	25/75	372.26
2"			
06140	2 x 1 1/2	1/40	417.89
06141	2 x 1 1/4	1/40	417.89
06142	2 x 1	15/45	524.20
06143	2 x 3/4	15/45	545.59
06144	2 x 1/2	15/45	545.59

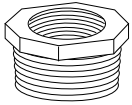

RÉDUCTEURS HEXAGONAUX			
#BMI	Taille	Emballage	\$
2 1/2"			
06146	2 1/2 x 2	15/30	1 004.47
06147	2 1/2 x 1 1/2	15/30	1 004.47
06149	2 1/2 x 1	15/30	1 263.53
06150	2 1/2 x 3/4	15/30	1 263.53
3"			
06151	3 x 2 1/2	10/20	1 769.92
06152	3 x 2	10/20	1 769.92
06153	3 x 1 1/2	10/20	2 121.23
4"			
06156	4 x 3	5/10	3 875.33
06157	4 x 2 1/2	5/10	3 875.33
06158	4 x 2	5/10	5 328.58

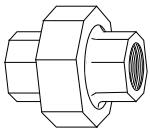

UNIONS			
#BMI	Taille	Emballage	\$
06101	1/8	40/160	278.04
06102	1/4	30/120	278.04
06103	3/8	25/100	278.04
06104	1/2	20/80	305.22
06105	3/4	10/40	362.32
06106	1	5/20	554.88
06107	1 1/4	5/15	813.46
06108	1 1/2	1/15	894.02
06109	2	1/10	1 503.43
06110	2 1/2	4/8	3 752.87
06111	3	4/8	6 960.37
06112	4	2/4	15 526.76

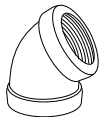

COUDES 45°			
#BMI	Taille	Emballage	\$
06201	1/8	140/840	100.46
06202	1/4	100/600	100.46
06203	3/8	40/200	100.46
06204	1/2	25/150	108.34
06205	3/4	20/80	164.93
06206	1	10/40	278.96
06207	1 1/4	10/30	443.10
06208	1 1/2	1/25	557.00
06209	2	1/10	902.59
06210	2 1/2	1/12	1 978.49



COUDES 45° (M x F)			
#BMI	Taille	Emballage	\$
06271	1/8	150/900	136.67
06272	1/4	100/600	136.67
06273	3/8	50/300	136.67
06274	1/2	40/160	147.85
06275	3/4	20/80	212.54
06276	1	15/60	360.54
06277	1 1/4	10/30	557.32
06278	1 1/2	1/20	827.57
06279	2	1/15	1 290.55



COUDES 90°			
#BMI	Taille	Emballage	\$
06301	1/8	50/300	92.66
06302	1/4	50/300	92.66
06303	3/8	35/210	92.66
06304	1/2	20/120	102.25
06305	3/4	20/80	176.45
06306	1	15/45	295.20
06307	1 1/4	5/20	442.76
06308	1 1/2	1/20	497.40
06309	2	1/10	913.43
06310	2 1/2	1/10	1 827.78
06311	3	1/8	3 356.69
06312	4	1/2	6 812.42

COUDES 90° RÉDUITS			
#BMI	Taille	Emballage	\$
06319	1/2 x 3/8	5/150	156.54
06320	1/2 x 1/4	25/150	156.54
06323	3/4 x 1/2	25/100	213.18
06327	1 x 3/4	15/60	372.26
06328	1 x 1/2	15/60	372.26
06331	1 1/4 x 1	1/40	565.48
06332	1 1/4 x 3/4	1/40	565.48
06337	1 1/2 x 1 1/4	1/20	719.48
06338	1 1/2 x 1	1/30	719.48
06339	1 1/2 x 3/4	1/35	719.48
06340	2 x 1 1/2	1/15	1 286.28
06341	2 x 1 1/4	1/15	1 286.28
06342	2 x 1	1/15	1 286.28

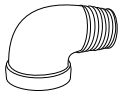

COUDES 90° (M x F)			
#BMI	Taille	Emballage	\$
06371	1/8	50/300	122.36
06372	1/4	50/300	122.36
06373	3/8	30/180	122.36
06374	1/2	30/120	148.40
06375	3/4	25/75	180.80
06376	1	10/40	297.13
06377	1 1/4	5/20	540.47
06378	1 1/2	1/10	722.81
06379	2	1/10	1 004.03
06380	2 1/2	5/10	2 081.08
06381	3	1/8	4 305.30

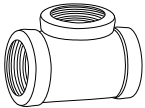

TÉS			
#BMI	Taille	Emballage	\$
06401	1/8	70/420	108.88
06402	1/4	60/360	106.58
06403	3/8	25/150	108.88
06404	1/2	25/75	148.97
06405	3/4	15/45	235.22
06406	1	10/40	389.15
06407	1 1/4	5/15	509.69
06408	1 1/2	1/20	775.68
06409	2	1/10	1 108.74
06410	2 1/2	4/8	2 493.43
06411	3	1/6	4 573.86
06412	4	1/2	11 320.07

TÉS RÉDUITS			
3/8", 1/2"			
#BMI	Taille	Emballage	\$
06418	3/8 x 3/8 x 1/8	25/200	180.78
06420	1/2 x 1/2 x 3/4	15/60	300.90
06421	1/2 x 1/2 x 3/8	25/100	195.34
06422	1/2 x 1/2 x 1/4	25/100	195.34

3/4"			
#BMI	Taille	Emballage	\$
06427	3/4 x 3/4 x 1	10/40	545.59
06429	3/4 x 3/4 x 1/2	15/60	236.41
06430	3/4 x 1/2 x 3/4	10/40	261.32
06431	3/4 x 1/2 x 1/2	15/60	259.33

1"			
#BMI	Taille	Emballage	\$
06438	1 x 1 x 3/4	10/30	545.59
06440	1 x 1 x 1/2	5/30	545.59
06437	1 x 1 x 1/4	15/45	545.59
06442	1 x 3/4 x 1	10/30	545.59
06444	1 x 3/4 x 3/4	10/30	545.59
06445	1 x 3/4 x 1/2	25/50	545.59
06450	1 x 1/2 x 1/2	5/30	545.59

TÉS RÉDUITS			
#BMI	Taille	Emballage	\$
1 1/4"			
06453	1 1/4 x 1 1/4 x 1	5/15	780.20
06454	1 1/4 x 1 1/4 x 3/4	5/15	780.20
06455	1 1/4 x 1 1/4 x 1/2	10/30	780.20
06458	1 1/4 x 1 x 1	5/15	780.20
06461	1 1/4 x 3/4 x 1 1/4	1/25	780.20
06465	1 1/4 x 1/2 x 1 1/4	5/15	780.20

1 1/2"			
#BMI	Taille	Emballage	\$
06471	1 1/2 x 1 1/2 x 1 1/4	1/15	1 050.38
06472	1 1/2 x 1 1/2 x 1	1/20	1 050.38
06473	1 1/2 x 1 1/2 x 3/4	1/20	1 050.38
06474	1 1/2 x 1 1/2 x 1/2	1/25	1 050.38
06482	1 1/2 x 1 x 1	1/20	1 050.38

2"			
#BMI	Taille	Emballage	\$
06494	2 x 2 x 1 1/2	1/10	1 759.16
06495	2 x 2 x 1 1/4	1/10	1 759.16
06496	2 x 2 x 1	1/10	1 759.16
06497	2 x 2 x 3/4	1/10	1 759.16
06498	2 x 2 x 1/2	1/10	1 759.16



CAPUCHONS			
#BMI	Taille	Emballage	\$
06501	1/8	200/1200	61.70
06502	1/4	150/900	61.70
06503	3/8	70/420	61.70
06504	1/2	60/240	78.42
06505	3/4	45/180	103.96
06506	1	30/120	149.10
06507	1 1/4	20/60	261.08
06508	1 1/2	1/40	342.89
06509	2	1/40	588.94
06510	2 1/2	1/16	1 249.27
06511	3	1/12	2 304.79
06512	4	1/8	4 420.92



CROIX			
#BMI	Taille	Emballage	\$
06802	1/4	50/300	202.70
06803	3/8	20/120	202.70
06804	1/2	20/60	270.24
06805	3/4	10/40	385.45
06806	1	5/15	617.02
06807	1 1/4	1/15	1 050.38
06808	1 1/2	1/10	1 390.99
06809	2	1/5	2 850.42

RACCORDS DE LAITON SANS PLOMB

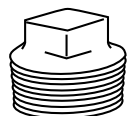

BOUCHONS À TÊTE CARRÉE - SOLIDES			
#BMI	Taille	Emballage	\$
06601	1/8	300/1800	76.00
06602	1/4	250/1500	76.00
06603	3/8	150/900	76.00
06614	1/2	70/420	101.05
06615	3/4	30/120	128.63
06616	1	30/120	207.49
06617	1 1/4	25/75	456.79
06618	1 1/2	15/60	512.39
06619	2	10/40	813.18

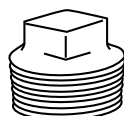

BOUCHONS À TÊTE CARRÉE			
06604	1/2	70/420	81.12
06605	3/4	60/240	94.34
06606	1	30/120	131.59
06607	1 1/4	25/75	178.99
06608	1 1/2	15/60	282.23
06609	2	10/40	374.82
06610	2 1/2	1/30	739.36
06611	3	1/24	1 402.32
06612	4	1/12	2 631.19



CONTRE-ÉCROUS			
06623	3/8	100/600	60.61
06624	1/2	90/540	65.51
06625	3/4	80/320	82.66
06626	1	60/240	133.70
06627	1 1/4	40/120	199.42
06629	2	1/60	359.52

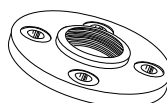

BRIDES COMPAGNON FILETÉES - 150 lbs			
06705	3/4 x 3 7/8	10/40	1 351.30
06706	1 x 4 1/4	5/20	1 550.17
06707	1 1/4 x 4 5/8	5/20	1 810.19
06708	1 1/2 x 5	1/20	2 513.90
06709	2 x 6	1/10	2 814.72
06710	2 1/2 x 7	1/6	4 558.61
06711	3 x 7 1/2	1/6	6 756.28
06712	4 x 9	1/3	9 662.77

RACCORDS "CHROMÉS" SANS PLOMB



MANCHONS CHROMÉS			
06633	3/8	25/450	455.88
06634	1/2	25/320	492.59

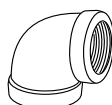

COUDES 90° CHROMÉS			
06643	3/8	25/400	552.25
06644	1/2	1/50	596.59

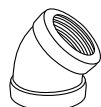

COUDES 45° CHROMÉS			
06637	1/2	25/200	650.12

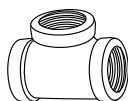

TÉS CHROMÉS			
06646	3/8	25/200	627.80
06647	1/2	25/100	688.37



Vancouver ~ Toronto ~ Montreal

www.bmicanada.com



1 800 361-1452



1 800 561-8579

LISTE DE PRIX BMI CANADA TUYAUX & MAMELONS DE LAITON TARAUDÉS - SCH. 40 SANS PLOMB

BPN 26-1

9 mars 2026



MAMELONS DE TUYAU EN LAITON TARAUDÉS SANS PLOMB

Diam.	Longueur		Close	1 1/2"	2"	2 1/2"	3"	3 1/2"	4"	4 1/2"	5"	5 1/2"	6"	7"	8"	10"	12"	
	Close	Close																
1/8"	3/4"	Close	49.02	56.83	62.02	68.00	76.50	83.33	91.19	98.47	105.30	112.54	121.57	133.56				
# BMI		04100	04115	04120	04125	04130	04135	04140	04145	04150	04155	04160	04167					
1/4"	7/8"	Close	56.83	64.22	72.90	83.62	92.90	108.77	117.77	137.09	175.44	188.03	202.66					
# BMI		04200	04215	04220	04225	04230	04235	04240	04245	04250	04255	04260						
3/8"	1"	Close	61.98	68.48	79.66	97.62	109.61	128.77	142.94	160.55	181.49	195.88	240.80					
# BMI		04300	04315	04320	04325	04330	04335	04340	04345	04350	04355	04360						
1/2"	1 1/8"	Close	73.39	86.41	104.87	124.92	143.89	168.13	192.01	210.58	230.03	252.44	271.57		370.12		543.38	
# BMI		04400	04415	04420	04425	04430	04435	04440	04445	04450	04455	04460		04468		04472		
3/4"	1 3/8"	Close	107.03	113.02	136.84	160.25	182.60	209.21	233.74	249.60	287.81	321.34	350.30		467.36			
# BMI		04500	04515	04520	04525	04530	04535	04540	04545	04550	04555	04560		04568				
1"	1 1/2"	Close	164.17		196.52	232.88	263.56	311.20	347.51	384.46	417.66	459.01	498.85		641.53		995.74	
# BMI		04600		04620	04625	04630	04635	04640	04645	04650	04655	04660		04668		04672		
1 1/4"	1 5/8"	Close	242.47		276.37	332.45	389.09	455.88	512.27	568.68	607.04	682.51	738.52					
# BMI		04700		04720	04725	04730	04735	04740	04745	04750	04755	04760						
1 1/2"	1 3/4"	Close	298.19		326.60	396.20	449.28	528.58	594.89	663.26	730.48	794.95	860.58					
# BMI		04800		04820	04825	04830	04835	04840	04845	04850	04855	04860						
2"	2"	Close	461.72			509.34	580.73	679.21	761.33	846.86	922.96	1017.53	1102.13					
# BMI		04900			04925	04930	04935	04940	04945	04950	04955	04960						
2 1/2"	2 1/2"	Close	1233.62				1310.64	1502.94	1658.34	1754.71	1907.59	2328.24	2209.43					
# BMI		04001				04002	04003	04004	04005	04006	04007	04008						
3"	2 5/8"	Close	1739.33				1818.64	2078.20	2311.45	2540.50	2769.25	2998.80	3228.07					
# BMI		04010				04011	04012	04013	04014	04015	04016	04017						
4"	2 7/8"	Close	2 582.42				2 645.14	3 081.76	3 415.16	3 769.40	4 123.57	4 457.09	4 811.24					
# BMI		04020				04021	04022	04023	04024	04025	04026	04027						
		Close		1 1/2"	2"	2 1/2"	3"	3 1/2"	4"	4 1/2"	5"	5 1/2"	6"	7"	8"	10"	12"	

EMBALLAGES

Diam.	Longueur															
	Close	Close	1 1/2"	2"	2 1/2"	3"	3 1/2"	4"	4 1/2"	5"	5 1/2"	6"	7"	8"	10"	12"
1/8"	Boîte	25	25	25	25	25	25	25	25	25	25	25	25	25		
	Caisse	800	750	600	600	600	500	500	500	500	400	400	200			
1/4"	Boîte	25	25	25	25	25	25	25	25	25	25	25				
	Caisse	600	800	500	300	300	300	300	300	200	150	100				
3/8"	Boîte	25	25	25	25	25	25	25	25	25	25	25				
	Caisse	800	600	500	300	300	250	200	150	150	200	150				
1/2"	Boîte	25	25	25	25	25	25	25	25	25	25	25		20	20	
	Caisse	600	400	200	200	200	150	150	100	100	100	100		80	60	
3/4"	Boîte	25	25	25	25	25	25	25	25	25	25	25		25		
	Caisse	300	300	200	200	150	150	150	100	100	75	75		50		
1"	Boîte	25		25	25	25	25	25	25	25	25	25		1	10	
	Caisse	200		150	100	100	100	75	75	75	75	50		50	50	
1 1/4"	Boîte	25		25	25	25	25	10	10	10	10	10				
	Caisse	150		100	100	75	75	40	40	40	40	40				
1 1/2"	Boîte	25		25	25	25	10	10	10	10	10	10				
	Caisse	75		75	50	50	30	30	30	30	30	30				
2"	Boîte	10			10	10	10	10	10	10	10	10				
	Caisse	60			30	30	30	30	30	30	30	30				
2 1/2"	Boîte	10				8	8	8	8	4	4	4				
	Caisse	30				24	24	24	24	12	12	12				
3"	Boîte	6				4	6	4	3	3	3	2				
	Caisse	18				16	12	12	9	9	9	8				
4"	Boîte	4				3	4	4	1	1	1	1				
	Caisse	12				9	8	8	8	8	8	8				
	Close		1 1/2"	2"	2 1/2"	3"	3 1/2"	4"	4 1/2"	5"	5 1/2"	6"	7"	8"	10"	12"

MAMELONS PLAQUÉS CHROME SANS PLOMB



# BMI	Taille	Emballage	\$
3/8"			
04963	3/8 x Close(1")	25/800	186.29
04964	3/8 x 1 1/2	25/600	206.82
04965	3/8 x 2	25/500	247.49
04966	3/8 x 2 1/2	25/300	293.26
04967	3/8 x 3	25/300	329.83
04968	3/8 x 3 1/2	25/250	385.43
04969	3/8 x 4	25/200	429.28
04970	3/8 x 4 1/2	25/150	482.02
04971	3/8 x 5	25/150	526.30
04972	3/8 x 5 1/2	25/200	567.00
04973	3/8 x 6	25/150	612.31

# BMI	Taille	Emballage	\$
1/2"			
04975	1/2 x Close(1-1/8")	25/600	220.06
04976	1/2 x 1 1/2	25/400	259.82
04977	1/2 x 2	25/200	316.09
04978	1/2 x 2 1/2	25/200	375.37
04979	1/2 x 3	25/200	432.66
04980	1/2 x 3 1/2	25/200	512.69
04981	1/2 x 4	25/150	576.49
04982	1/2 x 4 1/2	25/100	632.72
04983	1/2 x 5	25/100	689.26
04984	1/2 x 5 1/2	25/100	757.93
04985	1/2 x 6	25/100	814.84
04986	1/2 x 9	5/25	923.10
04987	1/2 x 12	5/25	1 158.05

TUYAUX DE LAITON ROUGE LONGUEURS DE 12'

# BMI	Taille	Emballage	\$	Note
24002	1/4 x 12'	1/10	796.30	**
24003	3/8 x 12'	1/6	1 153.61	**
24004	1/2 x 12'	1/5	1 722.42	**
24005	3/4 x 12'	1/3	2 323.73	**
24006	1 x 12'	1/3	3 239.12	**
24007	1 1/4 x 12'	1/3	4 785.82	**
24008	1 1/2 x 12'	1/1	5 695.82	**
24009	2 x 12'	1/1	7 497.41	**

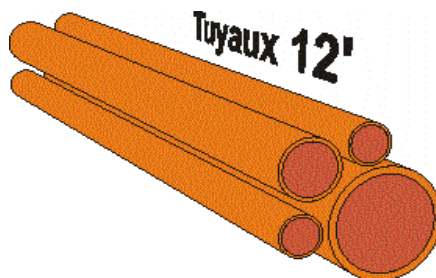

** LES TUYAUX DE LAITON ONT UN ESCOMPTE DIFFÉRENT DES MAMELONS DE LAITON



LISTE DE PRIX BMI CANADA VALVES À BILLE EN LAITON SANS PLOMB



**BBV
26-1**

9 mars 2026

VALVES À BILLE À SOUDER EN LAITON PLEIN DÉBIT

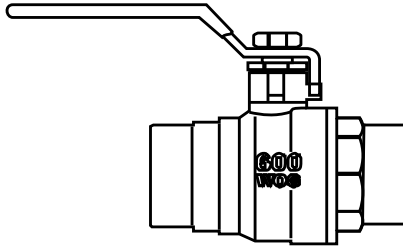

600CWP 150SWP				
BMI#	Taille	Emballage	Code à barres	\$
13204	1/2	10/100	777701132049	41.75
13205	3/4	10/80	777701132056	68.70
13206	1	8/48	777701132063	115.92
13207	1 1/4	4/36	777701132070	163.58
13208	1 1/2	2/24	777701132087	257.40
13209	2	2/12	777701132094	390.81

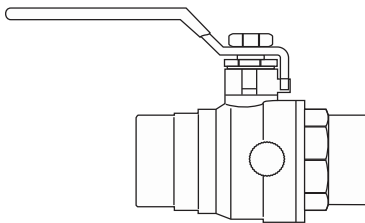

400CWP 100 SWP				
BMI#	Taille	Emballage	Code à barres	\$
13210	2 1/2	1/6	777701132100	883.11
13211	3	1/6	777701132117	1 207.00
13212	4	1/2	777701132124	2 462.31



VALVE À BILLE À SOUDER AVEC DRAIN				
BMI#	Taille	Emballage	Code à barres	\$
13224	1/2	10/100	777701132247	58.63
13225	3/4	10/80	777701132254	89.22
13226	1	6/48	777701132261	128.42

VALVES À BILLE TARAUDÉES EN LAITON PLEIN DÉBIT

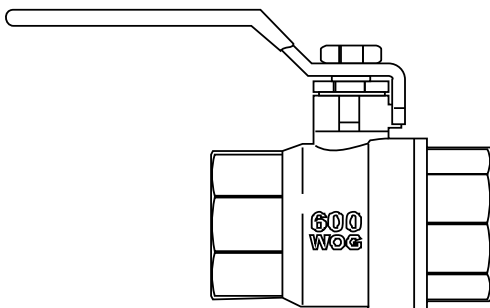

600CWP 150SWP				
BMI#	Taille	Emballage	Code à barres	\$
13102	1/4	10/120	777701131028	33.61
13103	3/8	10/120	777701131035	34.08
13104	1/2	10/100	777701131042	47.79
13105	3/4	10/80	777701131059	71.32
13106	1	8/48	777701131066	110.29
13107	1 1/4	4/36	777701131073	161.76
13108	1 1/2	2/24	777701131080	240.22
13109	2	2/12	777701131097	360.17

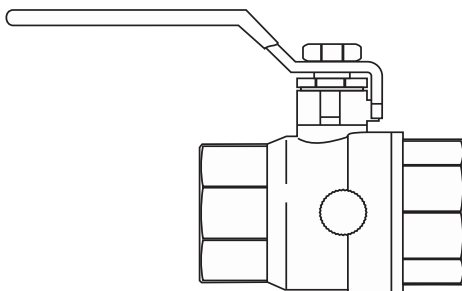

400CWP 100 SWP				
BMI#	Taille	Emballage	Code à barres	\$
13110	2 1/2	2/4	777701131103	1 042.01
13111	3	1/6	777701131110	1 290.54
13112	4	1/2	777701131127	2 491.50



VALVES À BILLE AVEC DRAIN				
BMI#	Taille	Emballage	Code à barres	\$
13124	1/2	10/100	777701131240	65.71
13125	3/4	6/60	777701131257	99.86
13126	1	8/48	777701131264	141.94



VALVES À BILLE TARAUDÉES EN LAITON PLEIN DÉBIT

Valves taraudées avec extension de tige et poignée à verrou

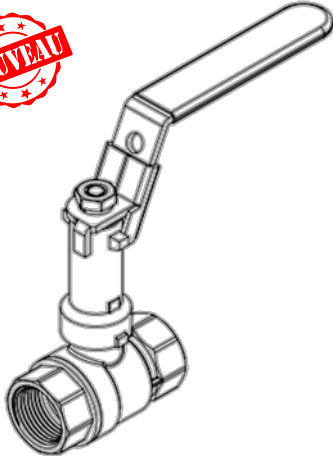

BMI#	Taille	Emballage	Code à barres	\$
13164	1/2	10/100	777701131646	102.93
13165	3/4	8/64	777701131653	154.17
13166	1	6/30	777701131660	203.17
13167	1 1/4	6/24	777701131677	280.50
13168	1 1/2	4/16	777701131684	375.70
13169	2	2/8	777701131691	518.90

VALVES À BILLE COMPRESSION EN LAITON PLEIN DÉBIT

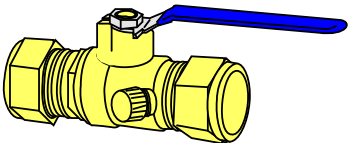
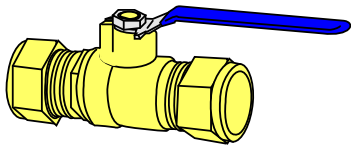

BMI#	Taille	Emballage	Code à barres	\$
13554	1/2	10/100	777701135545	55.88
13555	3/4	10/100	777701135552	111.27
13556	1	10/60	777701135569	158.82

AVEC DRAIN				
BMI#	Taille	Emballage	Code à barres	\$
13564	1/2	6/60	777701135644	62.78
13565	3/4	10/100	777701135651	115.91

VALVES À BILLE EXPANSION À FROID EN LAITON

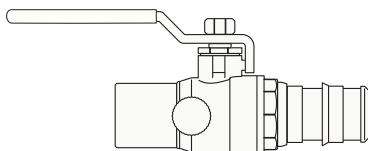
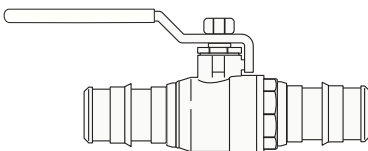
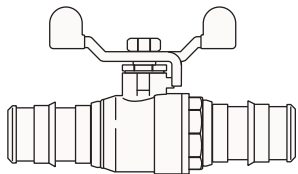

EXP. x EXP. AVEC POIGNÉE PAPILLON				
BMI#	Taille	Emballage	Code à barres	\$
13954	1/2	10/100	777701139543	62.42
13955	3/4	10/100	777701139550	85.67
13956	1	2/64	777701139567	110.13

EXP. x EXP. AVEC POIGNÉE DROITE				
BMI#	Taille	Emballage	Code à barres	\$
13854	1/2	10/100	777701138546	60.89
13855	3/4	10/100	777701138553	83.56
13856	1	8/80	777701138560	107.46
13857	1 1/4	4/50	777701138577	217.36
13858	1 1/2	2/24	777701138584	288.46
13859	2	2/12	777701138591	505.79

C x EXP. AVEC DRAIN				
BMI#	Taille	Emballage	Code à barres	\$
13874	1/2	10/100	777701138744	64.47
13875	3/4	10/100	777701138751	93.13



VALVES À BILLE « PRESS-FIT » EN LAITON PLEIN DÉBIT

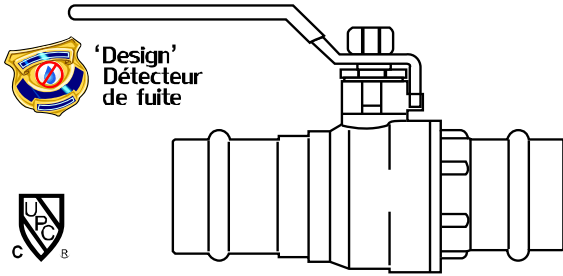

250PSI				
BMI#	Taille	Emballage	Code à barres	\$
13514	1/2	10/50	777701135149	96.56
13515	3/4	10/30	777701135156	137.16
13516	1	5/20	777701135163	240.61
13517	1 1/4	4/12	777701135170	345.80
13518	1 1/2	3/6	777701135187	481.22
13519	2	2/6	777701135194	743.42
13520	2 1/2	1/4	777701135200	987.85
13521	3	1/3	777701135217	1 412.66
13522	4	1/2	777701135224	2 469.70

VALVE AVEC DRAIN				
13314	1/2	10/50	777701133145	76.18
13315	3/4	10/30	777701133152	127.20
13316	1	5/20	777701133169	173.51

VALVES À BILLE « PRESS-FIT x PEX » EN LAITON

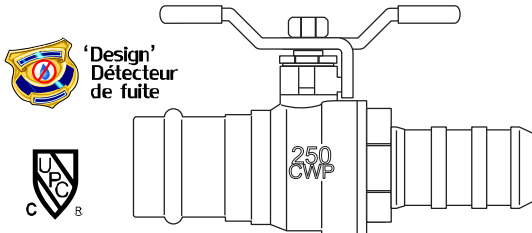

250PSI				
BMI#	Taille	Emballage	Code à barres	\$
13574	1/2	10/100	777701135743	96.56
13575	3/4	10/30	777701135750	137.16
13576	1	5/20	777701135767	240.61

VALVES À BILLE « PRESS-FIT x F1960 » EN LAITON

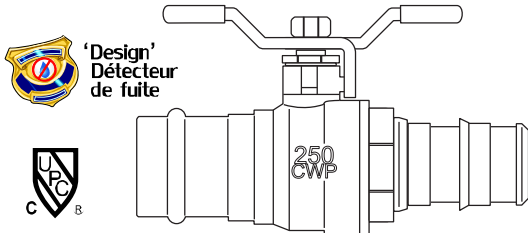

250PSI				
BMI#	Taille	Emballage	Code à barres	\$
13584	1/2	10/100	777701135842	101.37
13585	3/4	10/100	777701135859	147.73
13586	1	5/50	777701135866	252.68

VALVES À BILLE « PRESS-FIT x IPS » EN LAITON PLEIN DÉBIT

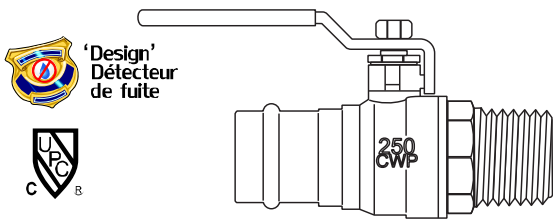

PRESS x MIPS				
BMI#	Taille	Emballage	Code à barres	\$
13614	1/2	5/50	777701136146	54.71
13615	3/4	10/30	777701136153	91.44
13616	1	2/20	777701136160	124.64
13617	1 1/4	4/12	777701136177	280.35
13618	1 1/2	3/6	777701136184	418.26
13619	2	2/6	777701136191	581.12

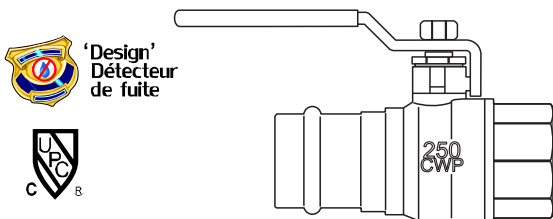

PRESS x FIPS				
BMI#	Taille	Emballage	Code à barres	\$
13604	1/2	5/50	777701136047	54.24
13605	3/4	5/30	777701136054	90.53
13606	1	2/20	777701136061	123.42
13607	1 1/4	4/12	777701136078	277.63
13608	1 1/2	3/6	777701136085	414.20
13609	2	2/6	777701136092	575.47



VALVES À BILLE PEX

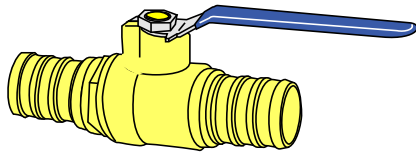

POIGNÉE DROITE BLEUE OU ROUGE				
Bleu	Rouge	Taille	Emballage	\$
13354	13454	1/2	10/100	36.24
13355	13455	3/4	10/100	49.01
13356	13456	1	10/100	82.19

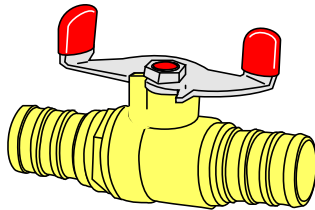

POIGNÉE PAPILLON BLEUE OU ROUGE				
Bleu	Rouge	Taille	Emballage	\$
13364	13464	1/2	10/100	37.36
13365	13465	3/4	10/100	50.13
13366	13466	1	6/60	84.17

VALVES À BILLE AVEC DRAIN PEX

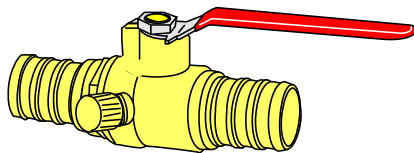

POIGNÉE DROITE BLEUE OU ROUGE				
Bleu	Rouge	Taille	Emballage	\$
13374	13474	1/2	10/100	40.89
13375	13475	3/4	10/100	54.71
13376	13476	1	6/60	91.38

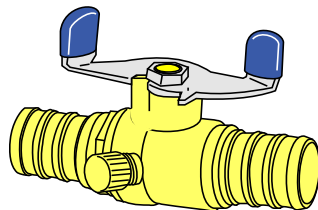

POIGNÉE PAPILLON BLEUE OU ROUGE				
Bleu	Rouge	Taille	Emballage	\$
13384	13484	1/2	10/100	41.99
13385	13485	3/4	10/100	55.80
13386	13486	1	5/100	93.63

VALVES À BILLE PEX x C

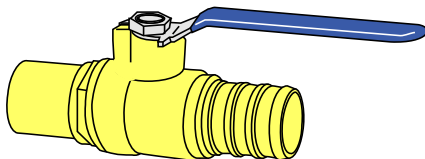

BMI#	Taille	Emballage	Code à barres	\$
13324	1/2	10/100	777701133244	38.96
13325	3/4	10/100	777701133251	52.83

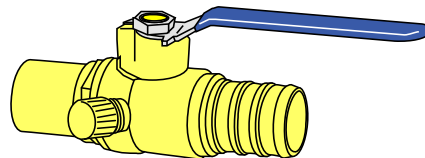

AVEC DRAIN CÔTÉ COP				
BMI#	Taille	Emballage	Code à barres	\$
13334	1/2	10/100	777701133343	51.48
13335	3/4	10/100	777701133350	64.00
13336	1	10/100	777701133367	88.56

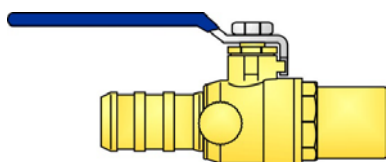

AVEC DRAIN CÔTÉ PEX				
BMI#	Taille	Emballage	Code à barres	\$
13344	1/2	10/100	777701133442	51.48
13345	3/4	10/100	777701133459	64.00
13346	1	10/100	777701133466	88.56



POIGNÉES ET EXTENSIONS DE TIGE POUR VALVES À BILLE

Ces articles sont uniquement vendus en multiples de quantités « INNER ». La quantité minimum est égale à un paquet « INNER ».

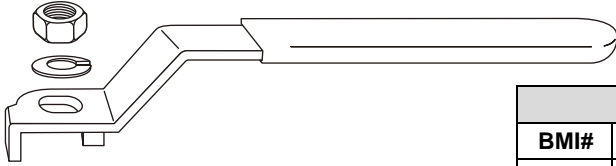

POIGNÉE EN ACIER INOXIDABLE					
BMI#	Taille	Qté min.	Emballage	Code à barres	\$
13001	1/4" à 1/2"	5	5/50	777701130014	8.05
13002	3/4" à 1"	5	5/30	777701130021	14.50
13003	1 1/4" à 2"	2	2/20	777701130038	24.09

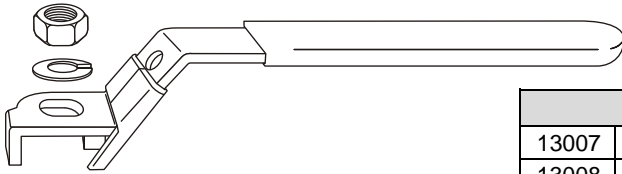

POIGNÉE À VERROU EN ACIER INOXIDABLE					
BMI#	Taille	Qté min.	Emballage	Code à barres	\$
13007	1/4" à 1/2"	5	5/50	777701130076	11.38
13008	3/4" à 1"	5	5/30	777701130083	19.40
13009	1 1/4" à 2"	2	2/20	777701130090	25.76

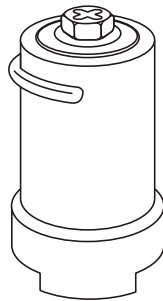

POIGNÉE À VERROU EN ACIER					
BMI#	Taille	Qté min.	Emballage	Code à barres	\$
13004	1/4" à 1/2"	5	5/50	777701130045	9.05
13005	3/4" à 1"	5	5/30	777701130052	9.70
13006	1 1/4" à 2"	2	2/20	777701130069	11.38

EXTENSION DE TIGE					
BMI#	Taille	Qté min.	Emballage	Code à barres	\$
13010	1/4" à 1/2"	5	5/50	777701130106	37.03
13011	3/4" à 1"	5	5/30	777701130113	53.10
13012	1 1/4" à 2"	2	2/20	777701130120	64.61

JOINT TORIQUE À VALVES « PRESS-FIT »

Ces articles sont vendus seulement en multiples de dix (10), soit en paquet « INNER ».

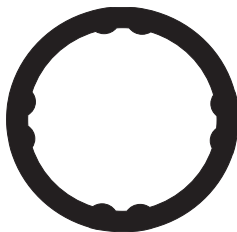

JOINT TORIQUE PRF EN CAOUTCHOUC					
BMI#	Taille	Qté min.	Emballage	Code à barres	\$
13544	1/2	10	10/400	777701135446	9.50
13545	3/4	10	10/300	777701135453	9.50
13546	1	10	10/200	777701135460	11.17
13547	1 1/4	10	10/150	777701135477	11.17
13548	1 1/2	10	10/100	777701135484	15.88
13549	2	10	10/80	777701135491	15.88

NON CONÇU POUR L'EAU POTABLE

VALVES À BILLE TARAUDÉES PLEIN DÉBIT (RÉGULIER)

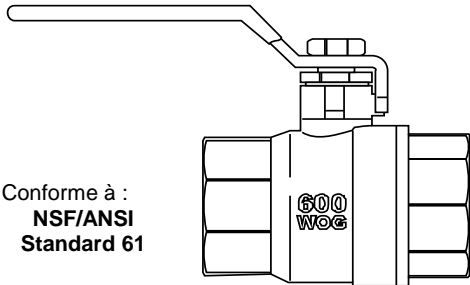

Conforme à :
NSF/ANSI
Standard 61



600CWP 150SWP				
BMI#	Taille	Emballage	Code à barres	\$
13802	1/4	10/120	777701138027	25.46
13803	3/8	10/120	777701138034	25.46
13804	1/2	10/100	777701138041	35.54
13805	3/4	10/80	777701138058	52.68
13806	1	8/48	777701138065	81.75
13807	1 1/4	4/36	777701138072	119.77
13808	1 1/2	2/24	777701138089	186.92
13809	2	2/12	777701138096	265.84

Conforme à :
NSF/ANSI
Standard 61



400CWP 100 SWP				
BMI#	Taille	Emballage	Code à barres	\$
13810	2 1/2	2/24	777701138102	598.96
13811	3	1/6	777701138119	897.74
13812	4	1/2	777701138126	1 425.28

VALVES À BILLE POUR APPAREIL AU GAZ POIGNÉE LEVIER

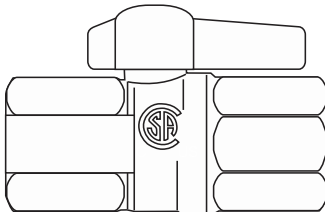

CSA[®] US
CAS/CGA
9.2-M88
1-9.1M81

POIGNÉE LEVIER JAUNE OU ROUGE				
JAUNE	ROUGE	Taille	Emballage	\$
13404	13504	1/2	10/100	27.76
13405	13505	3/4	10/100	36.61
13406	13506	1	6/60	64.00



LISTE DE PRIX BMI CANADA VALVES EN LAITON

**BRV
26-1**

9 mars 2026

NON CONÇU POUR L'EAU POTABLE

VALVES DE RETENUE 200 WOG

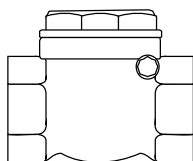

DISQUE À BATTANT EN LAITON

Valves de retenue en laiton
Vente finale - jusqu'à épuisement
des stocks

Voir la liste **BRVLS** pour les valves
de retenue en **laiton sans plomb**.

Taraudées

#BMI	Taille	Emballage	Code à barres	\$
14312	4	1/6	777701143120	756.48

VALVES À VANNE EN LAITON 200 WOG

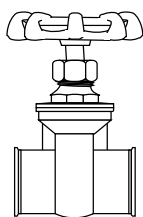

Valves à vanne en laiton
C x C
Vente finale - jusqu'à
épuisement des stocks

C x C

#BMI	Taille	Emballage	Code à barres	\$
14204	1/2	10/100	777701142048	25.67
14208	1 1/2	3/30	777701142086	93.50

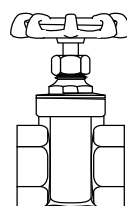

Valves à vanne en laiton taraudées
Vente finale - jusqu'à épuisement
des stocks

Voir la liste **BRVLS** pour les valves à
vanne en **laiton sans plomb**.

Taraudées







#BMI	Taille	Emballage	Code à barres	\$
14103	3/8	10/100	777701141034	26.07
14110	2 1/2	1/10	777701141102	332.52







NON CONÇU POUR L'EAU POTABLE

VALVES EN LAITON - BASSE PRESSION " CSA "







Voir la liste BRVLS pour les valves basse pression en **laiton sans plomb**.



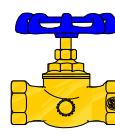

Emballage de 10 / 100

	PEX Robinet en laiton quart de tour		\$
14894	777701148941	1/2	36.10
	PEX Robinet en laiton multi tour		\$
14884	777701148842	1/2	35.21
	Brise-vide en laiton		\$
27001	777701270017	3/4	19.73
*** Voir la liste FFF pour votre multiplicateur ***			

	Valves de sédiment Sortie à 65°		\$
14754	777701147548	1/2	31.04
14755	777701147555	3/4	31.93
	Valves de sédiment Corps à 65°		\$
14764	777701147647	1/2	25.87
14765	777701147654	3/4	28.62
	Valves de sédiment Sortie à 65o, modèle "O-Ring"		\$
14854	777701148545	1/2	34.76
14855	777701148552	3/4	35.95

JUSQU'À ÉPUISEMENT DES STOCKS - VENTE FINALE

	Valves d'arrêt CxC modèle "O-Ring"		\$
14825	777701148255	1/2	18.23
14835	777701148354	3/4	21.38
	Valves d'arrêt CxC avec vidange modèle "O-Ring"		\$
14826	777701148262	1/2	19.28
14836	777701148361	3/4	22.20
	Valves d'arrêt FIPS x FIPS avec vidange		\$
14744	777701147449	1/2	20.26
14745	777701147456	3/4	22.36

	Valves d'arrêt CxC avec vidange		\$
14736	777701147364	3/4	20.86
	Valves d'arrêt CxC		\$
14725	777701147258	1/2	17.04
14735	777701147357	3/4	19.97

LISTE DE PRIX BMI CANADA VALVES EN LAITON SANS PLOMB



**BRV
26-1**

9 mars 2026

VALVES DE RETENUE 200 WOG

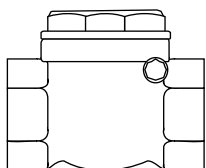

DISQUE À BATTANT EN LAITON



Taraudées				
#BMI	Taille	Emballage	Code à barres	\$
14324	1/2	10/120	777701143243	34.90
14325	3/4	5/60	777701143250	46.32
14326	1	5/80	777701143267	67.47
14327	1 1/4	5/30	777701143274	113.25
14328	1 1/2	4/24	777701143281	158.07
14329	2	4/24	777701143298	227.54

C x C				
#BMI	Taille	Emballage	Code à barres	\$
14424	1/2	10/100	777701144240	34.90
14425	3/4	10/80	777701144257	46.32
14426	1	5/40	777701144264	77.59
14427	1 1/4	5/30	777701144271	130.23
14428	1 1/2	5/30	777701144288	181.78
14429	2	1/12	777701144295	261.68

VALVES À VANNE EN LAITON 200 WOG

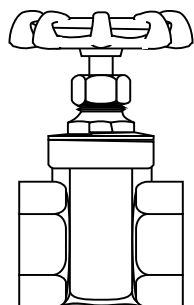

Taraudées				
#BMI	Taille	Emballage	Code à barres	\$
14124	1/2	10/100	777701141249	49.66
14125	3/4	10/100	777701141256	67.93
14126	1	5/50	777701141263	100.91
14127	1 1/4	5/40	777701141270	142.61
14128	1 1/2	5/30	777701141287	181.31
14129	2	2/20	777701141294	275.77

VALVES À VANNE EN LAITON 200 WOG

Valves de sédiment
« PRESS-FIT »

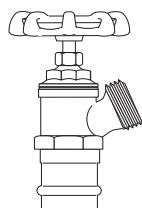

#BMI	Taille	Emballage	Code à barres	\$
Valves de sédiment « PRESS-FIT »				
14752	1/2	10/100	777701147524	44.28
14753	3/4	10/100	777701147531	49.45

Valves de sédiment
quart de tour

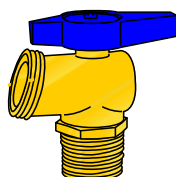

1/2 " C / MIPS
3/4 " MIPS

Valves de sédiment
type cartouche



Valves de sédiment quart de tour				
#BMI	Taille	Emballage	Code à barres	\$
14794	1/2	10/100	777701147944	23.77
14795	3/4	10/100	777701147951	26.44

Valves de sédiment type cartouche				
#BMI	Taille	Emballage	Code à barres	\$
14964	1/2	10/100	777701149641	35.53
14965	3/4	10/100	777701149658	37.93



LISTE DE PRIX BMI CANADA ROBINETS ANTIGEL

FFF
26-1

9 mars 2026

NON CONÇU POUR L'EAU POTABLE

ROBINETS ANTIGEL ULTRA - À ROTATION COURTE

COP ou MIPS x 1/2"				
#BMI	Taille	Emballage	Code à barres	\$
27404	4	1/25	777701274046	119.08
27406	6	1/25	777701274060	124.45
27408	8	1/25	777701274084	129.71
27410	10	1/25	777701274107	135.10
27412	12	1/25	777701274121	140.50
27414	14	1/25	777701274145	145.86
27418	18	1/25	777701274183	161.89

27432	12 x 3/4"	1/25	777701274329	141.44
-------	-----------	------	--------------	--------

PEX x 1/2"				
#BMI	Taille	Emballage	Code à barres	\$
27504	4	1/25	777701275043	119.08
27506	6	1/25	777701275067	124.45
27508	8	1/25	777701275081	129.71
27510	10	1/25	777701275104	135.10
27512	12	1/25	777701275128	140.50
27514	14	1/25	777701275142	145.86
27518	18	1/25	777701275180	161.89

EXPANSION À FROID x 1/2"				
#BMI	Taille	Emballage	Code à barres	\$
27818	8	1/25	777701278181	173.78
27820	10	1/25	777701278204	180.97
27822	12	1/25	777701278228	188.36
27824	14	1/25	777701278242	195.42

ROBINETS ANTIGEL ULTRA - À ROTATION COURTE

Rotation 3/4 de tour pour un meilleur contrôle de débit.

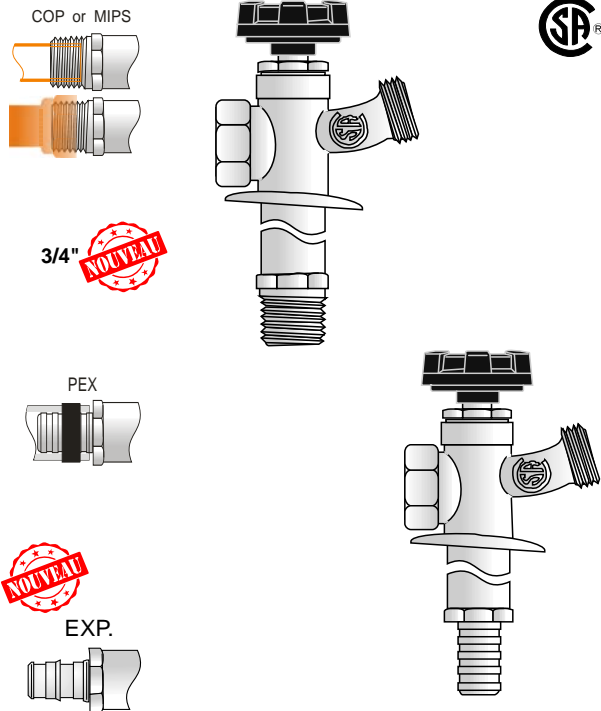

ROBINETS ANTIGEL QUART DE TOUR

PEX x 1/2"				
#BMI	Taille	Emballage	Code à barres	\$
27210	10	1/25	777701272103	127.68

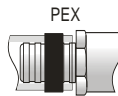

**DISCONTINUÉS - JUSQU'À ÉPUISEMENT
DES STOCKS**

Les robinets antigel quart de tour sont discontinués et remplacés par les robinets Ultra - à rotation courte.



NON CONÇU POUR L'EAU POTABLE

ROBINETS ANTIGEL CHAUD ET FROID

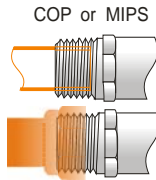

COP ou MIPS x 1/2"				
#BMI	Taille	Emballage	Code à barres	\$
27804	4	1/10	777701278044	468.56
27806	6	1/10	777701278068	518.34
27808	8	1/10	777701278082	562.25
27810	10	1/10	777701278105	607.98
27812	12	1/10	777701278129	643.09
27814	14	1/10	777701278143	692.28

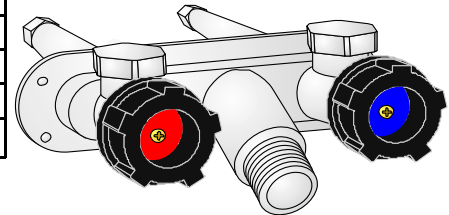

ENSEMBLE DE TIGE POUR ROBINETS CHAUD & FROID

#BMI	Taille	Emballage	Code à barres	\$
27924	4	1/25	777701279249	47.35
27926	6	1/25	777701279263	49.68
27928	8	1/25	777701279287	57.53
27930	10	1/25	777701279300	60.31
27932	12	1/25	777701279324	64.10
27934	14	1/25	777701279348	66.95

ENSEMBLE DE BRISE-VIDE

#BMI	Emballage	Code à barres	\$
27883	1/50	777701278839	13.57

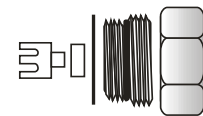

ENSEMBLE DE POIGNÉE EN ALUMINIUM et ABS

#BMI	Emballage	Code à barres	\$
27884	25/100	777701278846	14.86



NON CONÇU POUR L'EAU POTABLE**PIÈCES POUR ROBINETS ANTIGEL QUART DE TOUR****ENSEMBLE DE TIGE**

#BMI	Taille	Emballage	Code à barres	\$
27604	4	1/25	777701276040	69.04
27606	6	1/25	777701276064	72.35
27608	8	1/25	777701276088	76.16
27610	10	1/25	777701276101	79.91
27612	12	1/25	777701276125	84.91
27614	14	1/25	777701276149	88.64
27618	18	1/25	777701276187	114.14

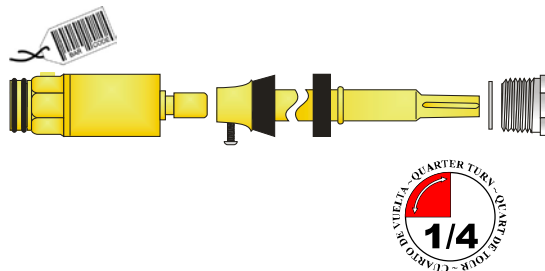
**ENSEMBLE DE BRISE-VIDE**

#BMI	Emballage	Code à barres	\$
27883	1/50	777701278839	13.57

**ENSEMBLE DE POIGNÉE EN ALUMINIUM et ABS**

#BMI	Emballage	Code à barres	\$
27884	25/100	777701278846	14.86

**PIÈCES POUR ROBINETS ULTRA - À ROTATION COURTE****ENSEMBLE DE TIGE**

#BMI	#BMI	Taille	Emballage	Code à barres	\$
ULTRA	ULTRA 'A'				
27704	27724	4	1/25	777701277047	47.35
27706	27726	6	1/25	777701277061	49.68
27708	27728	8	1/25	777701277085	57.53
27710	27730	10	1/25	777701277108	60.31
27712	27732	12	1/25	777701277122	64.10
27714	27734	14	1/25	777701277146	66.95
27718	27738	18	1/25	777701277184	86.22

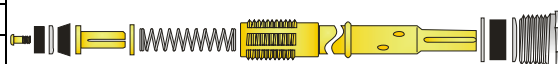
**ENSEMBLE DE BRISE-VIDE**

#BMI	Emballage	Code à barres	\$
27883	1/50	777701278839	13.57

**ENSEMBLE DE POIGNÉE EN ALUMINIUM et ABS**

#BMI	Emballage	Code à barres	\$
27884	25/100	777701278846	14.86

**PIÈCES POUR ROBINETS ANTIGEL INDONÉSIE****ENSEMBLE DE TIGE**

#BMI	Taille	Emballage	Code à barres	\$
27908	8	25/100	777701279089	49.62
27910	10	25/100	777701279102	52.02
27912	12	25/100	777701279126	55.26
27914	14	25/100	777701279140	57.70
27918	18	25/100	777701279188	74.30

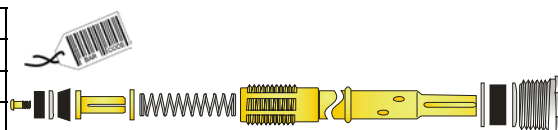

**LISTE DE PRIX BMI CANADA
RACCORDS EN CUIVRE "BMI PRESS-FIT"**

**CPF
26-1**

9 mars 2026

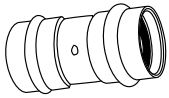

MANCHONS OUVRÉS PRF x PRF					
#BMI	#Jungwoo	#Viega	Taille	Emballage	\$
47004	50170	78047	1/2	10/450	6.22
47005	50171	78052	3/4	10/240	10.20
47006	50172	78057	1	5/150	18.29
47007	50173	78062	1 1/4	1/75	23.58
47008	50174	78067	1 1/2	1/50	45.13
47009	50175	78072	2	1/30	57.53
47010	50176	20728	2 1/2	1/24	175.47
47011	50177	20733	3	1/16	223.41
47012	50178	20738	4	1/6	316.22

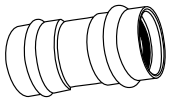

MANCHONS OUVRÉS PRF x PRF SANS ARRÊT					
#BMI	#Jungwoo	#Viega	Taille	Emballage	\$
47074	50155	78172	1/2	10/450	14.92
47075	50156	78177	3/4	10/240	19.56
47076	50157	78182	1	5/150	24.90
47077	50158	78187	1 1/4	1/75	38.65
47078	50159	78192	1 1/2	1/50	58.43
47079	50160	78197	2	1/30	66.75
47080	50161	20743	2 1/2	1/24	177.88
47081	50162	20748	3	1/16	229.70
47082	50163	20753	4	1/4	316.22

MANCHONS COULISSANTS OUVRÉS PRF x PRF SANS ARRÊT					
#BMI	#Jungwoo	#Viega	Taille	Emballage	\$
47084	50164	79005	1/2	5/225	41.33
47085	50165	79010	3/4	5/120	45.99
47086	50166	79015	1	5/75	58.09
47087	50167	79020	1 1/4	1/36	74.34
47088	50168	79025	1 1/2	1/25	108.66
47089	50169	79030	2	1/15	133.02

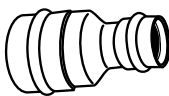

MANCHONS OUVRÉS RÉDUITS PRF x PRF					
#BMI	#Jungwoo	#Viega	Taille	Emballage	\$
47023	50107	78147	3/4 x 1/2	10/300	27.59
47028	50108	15603	1 x 1/2	10/200	29.74
47027	50109	78152	1 x 3/4	10/200	32.26
47033	50327	N/A	1 1/4 x 1/2	1/100	110.17
47032	50110	15593	1 1/4 x 3/4	1/100	46.46
47031	50111	78157	1 1/4 x 1	1/80	48.59
47038	50328	N/A	1 1/2 x 1/2	1/75	62.96
47037	50112	18473	1 1/2 x 3/4	1/75	62.96
47036	50113	15588	1 1/2 x 1	1/75	66.55
47035	50114	78162	1 1/2 x 1 1/4	1/60	71.53
47044	50329	N/A	2 x 1/2	1/40	200.17
47043	50115	18468	2 x 3/4	1/40	81.14
47042	50116	15608	2 x 1	1/40	83.16
47041	50117	22328	2 x 1 1/4	1/40	87.16
47040	50118	78167	2 x 1 1/2	1/40	98.52
47049	50119	20685	2 1/2 x 1	1/25	315.77
47048	50120	20690	2 1/2 x 1 1/4	1/25	328.34
47047	50121	20695	2 1/2 x 1 1/2	1/25	331.75
47046	50122	20700	2 1/2 x 2	1/25	333.91
47052	50124	20710	3 x 2	1/12	368.03
47051	50125	20715	3 x 2 1/2	1/12	431.48
47058	50126	20720	4 x 2	1/8	457.71
47057	50127	20725	4 x 2 1/2	1/8	505.34
47056	50128	20730	4 x 3	1/8	556.32

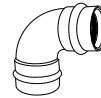

COUDES OUVRÉS 90° PRF x PRF					
#BMI	#Jungwoo	#Viega	Taille	Emballage	\$
47304	50087	77317	1/2	10/350	8.23
47305	50088	77022	3/4	10/180	13.80
47306	50089	77027	1	5/100	24.71
47307	50090	77032	1 1/4	1/50	45.26
47308	50091	77037	1 1/2	1/30	85.61
47309	50092	77042	2	1/15	118.97
47310	50093	20623	2 1/2	1/8	352.23
47311	50094	20628	3	1/5	443.14
47312	50095	20633	4	1/2	548.25

COUDES 90° RÉDUIT PRF x PRF					
#BMI	#Jungwoo	#Viega	Taille	Emballage	\$
47323	50096	77325	3/4 x 1/2	15/210	15.02
47327	50097	77330	1 x 3/4	10/80	34.03

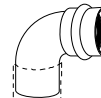

COUDES OUVRÉS 90° RACCORD x PRF					
#BMI	#Jungwoo	#Viega	Taille	Emballage	\$
47354	50098	77347	1/2	10/400	8.20
47355	50099	77052	3/4	10/200	13.77
47356	50100	77057	1	5/120	26.76
47357	50101	77062	1 1/4	1/55	49.30
47358	50102	77067	1 1/2	1/35	90.57
47359	50103	77072	2	1/15	124.56
47360	50104	20638	2 1/2	1/10	394.45
47361	50105	20643	3	1/5	458.68
47362	50106	20648	4	1/2	584.15



COUDES OUVRÉS 45° PRF x PRF					
#BMI	#Jungwoo	#Viega	Taille	Emballage	\$
47204	50058	77607	1/2	10/400	8.04
47205	50059	77023	3/4	10/200	11.30
47206	50060	77028	1	5/120	31.53
47207	50061	77033	1 1/4	1/70	45.20
47208	50062	77038	1 1/2	1/40	73.23
47209	50063	77043	2	1/25	100.51
47210	50064	20653	2 1/2	1/12	237.20
47211	50065	20658	3	1/6	332.42
47212	50066	20663	4	1/2	470.90



COUDES OUVRÉS 45° RACCORD x PRF					
#BMI	#Jungwoo	#Viega	Taille	Emballage	\$
47254	50067	77637	1/2	10/450	7.18
47255	50068	77053	3/4	10/200	11.21
47256	50069	77058	1	5/140	30.74
47257	50070	77063	1 1/4	1/70	45.23
47258	50071	77068	1 1/2	1/40	70.90
47259	50072	77073	2	1/25	102.53
47260	50073	20668	2 1/2	1/12	289.32
47261	50074	20673	3	1/6	418.55
47262	50075	20678	4	1/4	528.77

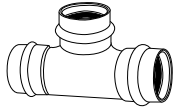

TÉS OUVRÉS PRF x PRF x PRF					
#BMI	#Jungwoo	#Viega	Taille	Emballage	\$
47404	50179	77377	1/2	10/200	12.78
47405	50180	77387	3/4	10/100	22.41
47406	50181	77412	1	5/60	35.54
47407	50182	77442	1 1/4	1/40	57.09
47408	50183	77457	1 1/2	1/25	107.40
47409	50184	77477	2	1/15	132.70
47410	50185	20683	2 1/2	1/6	443.54
47411	50186	20693	3	1/4	543.96
47412	50187	20708	4	1/2	777.92

TÉS OUVRÉS RÉDUITS PRF x PRF x PRF					
#BMI	#Jungwoo	#Viega	Taille	Emballage	\$
47420	50188	77382	1/2 x 1/2 x 3/4	10/150	41.66
47419	50189	15493	1/2 x 1/2 x 1	5/100	50.09
47431	50192	77392	3/4 x 1/2 x 1/2	10/120	28.57
47430	50193	77397	3/4 x 1/2 x 3/4	5/100	31.06
47429	50190	77402	3/4 x 3/4 x 1/2	10/120	18.85
47428	50191	77407	3/4 x 3/4 x 1	5/80	52.77
47450	N/A	N/A	1 x 1/2 x 1/2	1/80	86.28
47449	50201	22263	1 x 1/2 x 3/4	5/80	81.73
47448	50200	94767	1 x 1/2 x 1	5/70	59.33
47445	50199	77417	1 x 3/4 x 1/2	5/80	59.83
47443	50198	77422	1 x 3/4 x 3/4	5/80	52.61
47442	50197	77427	1 x 3/4 x 1	5/70	59.44
47439	50194	77432	1 x 1 x 1/2	5/80	41.30
47438	50195	77437	1 x 1 x 3/4	5/80	41.78
47437	50196	15488	1 x 1 x 1 1/4	1/50	102.73
47465	50205	22253	1 1/4 x 1/2 x 1 1/4	1/50	104.81
47463	50207	22258	1 1/4 x 3/4 x 3/4	1/50	91.48
47462	50208	22268	1 1/4 x 3/4 x 1	1/50	95.13
47461	50209	22248	1 1/4 x 3/4 x 1 1/4	1/40	84.16
47460	50210	22238	1 1/4 x 1 x 1/2	1/60	65.25
47459	50211	94762	1 1/4 x 1 x 3/4	1/60	59.33
47458	50212	14568	1 1/4 x 1 x 1	1/50	65.00
47455	50202	94757	1 1/4 x 1 1/4 x 1/2	1/50	49.07
47454	50203	77452	1 1/4 x 1 1/4 x 3/4	1/50	52.18
47453	50204	77447	1 1/4 x 1 1/4 x 1	1/50	56.45
47483	50217	79660	1 1/2 x 1 x 3/4	1/40	146.61
47482	50218	15458	1 1/2 x 1 x 1	1/40	163.65
47480	50219	15463	1 1/2 x 1 x 1 1/2	1/30	160.29
47478	50220	22233	1 1/2 x 1 1/4 x 3/4	1/30	112.33
47477	50221	15453	1 1/2 x 1 1/4 x 1	1/30	130.21
47476	50222	15483	1 1/2 x 1 1/4 x 1 1/4	1/30	109.70
47474	50213	15448	1 1/2 x 1 1/2 x 1/2	1/40	116.54
47473	50214	77462	1 1/2 x 1 1/2 x 3/4	1/35	96.91
47472	50215	77467	1 1/2 x 1 1/2 x 1	1/30	101.83
47471	50216	77472	1 1/2 x 1 1/2 x 1 1/4	1/30	107.09
47532	50336	N/A	2 x 1/2 x 2	1/1	284.60
47529	50348	N/A	2 x 3/4 x 2	1/20	284.60
47527	50334	N/A	2 x 1 x 1	1/20	286.06
47525	50335	N/A	2 x 1 x 2	1/20	261.88
47523	50228	15518	2 x 1 1/4 x 1 1/4	1/20	214.07
47520	50229	15513	2 x 1 1/2 x 3/4	1/15	183.52
47519	50230	15498	2 x 1 1/2 x 1	1/15	181.17
47518	50231	15508	2 x 1 1/2 x 1 1/4	1/15	187.16
47517	50232	15503	2 x 1 1/2 x 1 1/2	1/15	212.53
47516	50233	22228	2 x 1 1/2 x 2	1/10	176.65
47498	50223	15538	2 x 2 x 1/2	1/25	183.70
47497	50224	94777	2 x 2 x 3/4	1/25	155.32
47496	50225	94772	2 x 2 x 1	1/20	160.51
47495	50226	77487	2 x 2 x 1 1/4	1/20	163.58
47491	50227	77482	2 x 2 x 1 1/2	1/16	132.20

TÉS OUVRÉS RÉDUITS PRF x PRF x PRF					
#BMI	#Jungwoo	#Viega	Taille	Emballage	\$
47541	50247	22278	2 1/2 x 2 x 2	1/15	518.48
47539	50234	22303	2 1/2 x 2 1/2 x 1/2	1/6	571.88
47538	50235	22298	2 1/2 x 2 1/2 x 3/4	1/6	606.88
47537	50236	22293	2 1/2 x 2 1/2 x 1	1/6	606.88
47536	50237	22288	2 1/2 x 2 1/2 x 1 1/4	1/6	618.56
47535	50238	20803	2 1/2 x 2 1/2 x 1 1/2	1/6	591.10
47534	50239	20688	2 1/2 x 2 1/2 x 2	1/6	521.05
47555	50249	20759	3 x 3 x 1/2	1/4	635.63
47554	50250	22323	3 x 3 x 3/4	1/4	651.89
47553	50251	22308	3 x 3 x 1	1/4	651.89
47552	50252	22313	3 x 3 x 1 1/4	1/4	651.89
47551	50253	20798	3 x 3 x 1 1/2	1/4	651.89
47550	50254	20698	3 x 3 x 2	1/4	625.80
47549	50255	20703	3 x 3 x 2 1/2	1/4	690.38
47577	50266	20788	4 x 4 x 1/2	1/2	985.18
47576	50267	20793	4 x 4 x 3/4	1/2	972.05
47575	50268	20794	4 x 4 x 1	1/2	722.22
47574	50269	20795	4 x 4 x 1 1/4	1/2	877.07
47573	50270	20808	4 x 4 x 1 1/2	1/2	817.04
47572	50271	20713	4 x 4 x 2	1/2	704.12
47571	50272	20718	4 x 4 x 2 1/2	1/2	670.93
47570	50273	20723	4 x 4 x 3	1/2	735.46

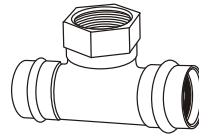

TÉS OUVRÉS PRF x PRF x F					
#BMI	#Jungwoo	#Viega	Taille	Emballage	\$
47594	50276	79580	1/2	5/120	57.41
47595	50279	79595	3/4	5/100	87.40

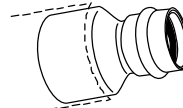

RÉDUCTEURS OUVRÉS RACCORD x PRF					
#BMI	#Jungwoo	#Viega	Taille	Emballage	\$
47123	50129	78077	3/4 x 1/2	10/350	7.64
47128	50130	78082	1 x 1/2	10/300	18.33
47127	50131	78087	1 x 3/4	10/240	18.69
47133	50132	22333	1 1/4 x 1/2	5/150	20.07
47132	50133	78092	1 1/4 x 3/4	5/150	22.54
47131	50134	78097	1 1/4 x 1	5/150	25.37
47138	50135	79850	1 1/2 x 1/2	1/80	82.92
47137	50136	14543	1 1/2 x 3/4	1/80	37.66
47136	50137	78102	1 1/2 x 1	1/75	37.24
47135	50138	78107	1 1/2 x 1 1/4	1/75	37.47
47144	50139	79855	2 x 1/2	1/50	92.81
47143	50140	79860	2 x 3/4	1/50	93.82
47142	50141	78112	2 x 1	1/50	42.21
47141	50142	78117	2 x 1 1/4	1/50	51.66
47140	50143	78122	2 x 1 1/2	1/40	50.23
47149	50144	20814	2 1/2 x 1	1/30	163.98
47148	50145	20815	2 1/2 x 1 1/4	1/30	230.44
47147	50146	20813	2 1/2 x 1 1/2	1/30	259.62
47146	50147	20758	2 1/2 x 2	1/30	223.24
47154	50148	20817	3 x 1 1/4	1/15	266.83
47153	50149	20818	3 x 1 1/2	1/15	284.00
47152	50150	20763	3 x 2	1/15	276.37
47151	50151	20768	3 x 2 1/2	1/15	284.72
47158	50152	20773	4 x 2	1/10	318.09
47157	50153	20778	4 x 2 1/2	1/10	347.56
47156	50154	20783	4 x 3	1/10	367.32

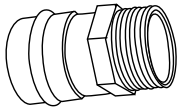

ADAPTATEURS OUVRÉS PRF x M					
#BMI	#Jungwoo	#Viega	Taille	Emballage	\$
47804	50015	79215	1/2	10/300	9.74
47805	50016	79230	3/4	10/200	17.60
47806	50017	79245	1	10/160	31.99
47807	50018	79260	1 1/4	1/80	65.15
47808	50019	79275	1 1/2	1/55	97.95
47809	50020	79290	2	1/35	179.57
47810	50021	20823	2 1/2	1/24	410.24
47811	50022	20828	3	1/16	536.04
47812	50023	20838	4	1/6	613.44

ADAPTATEURS OUVRÉS RÉDUITS PRF x M					
#BMI	#Jungwoo	#Viega	Taille	Emballage	\$
47822	50024	79220	1/2 x 3/4	10/250	18.79
47823	50025	79225	3/4 x 1/2	10/200	19.85
47827	50026	79235	3/4 x 1	10/160	44.31
47833	50027	79240	1 x 3/4	10/120	49.65
47831	50028	79250	1 x 1 1/4	1/100	61.84
47836	50029	79255	1 1/4 x 1	1/100	70.35
47835	50030	79265	1 1/4 x 1 1/2	1/50	76.52
47839	50031	79270	1 1/2 x 1 1/4	1/75	94.75
47842	50032	79280	1 1/2 x 2	1/40	206.92

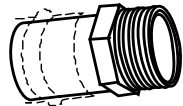

ADAPTATEURS OUVRÉS RACCORD PRF x M					
#BMI	#Jungwoo	#Viega	Taille	Emballage	\$
47884	50040	79380	1/2	5/500	28.74
47885	50043	79395	3/4	5/300	47.85
47886	50045	79405	1	5/200	71.58
47887	50046	79410	1 1/4	1/100	96.70
47888	50047	79415	1 1/2	1/60	144.31
47889	50048	79420	2	1/30	221.33

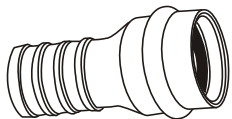

ADAPTATEURS OUVRÉS PRF x PEX					
#BMI	#Jungwoo	#Viega	Taille	Emballage	\$
47944	N/A	44350	1/2	10/500	10.75
47945	N/A	44365	3/4	10/400	16.10
47946	N/A	44370	1	10/250	24.50

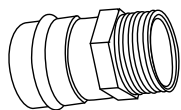

ADAPTATEURS EN LAITON PRF x M					
#BMI	#Jungwoo	#Viega	Taille	Emballage	\$
47854	N/A	N/A	1/2	10/300	9.74
47855	N/A	N/A	3/4	10/200	17.60
47856	N/A	N/A	1	10/160	31.99

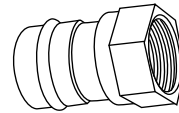

ADAPTATEURS OUVRÉS PRF x F					
#BMI	#Jungwoo	#Viega	Taille	Emballage	\$
47704	50001	79300	1/2	10/300	11.68
47705	50002	79315	3/4	10/200	18.99
47706	50003	79330	1	10/160	34.98
47707	50004	79350	1 1/4	1/75	79.09
47708	50005	79365	1 1/2	1/55	115.13
47709	50006	79370	2	1/35	189.51
47710	50322	20819	2 1/2	1/25	454.58
47711	50323	20829	3	1/16	704.35
47712	N/A	20839	4	1/8	1 007.30

ADAPTATEURS OUVRÉS RÉDUITS PRF x F					
#BMI	#Jungwoo	#Viega	Taille	Emballage	\$
47717	50007	79305	1/2 x 3/4	10/250	24.09
47723	50008	79310	3/4 x 1/2	10/200	26.82
47728	50009	79320	1 x 1/2	10/150	60.02
47727	50010	79325	1 x 3/4	10/120	60.24
47726	50011	79335	1 x 1 1/4	10/100	64.40
47733	50012	79345	1 1/4 x 1	1/100	77.92
47732	50013	79355	1 1/4 x 1 1/2	1/50	105.32
47736	50014	79360	1 1/2 x 1 1/4	1/50	107.01

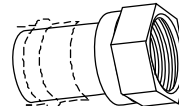

ADAPTATEURS OUVRÉS RACCORD PRF x F					
#BMI	#Jungwoo	#Viega	Taille	Emballage	\$
47784	50034	79430	1/2	5/400	31.36
47785	50035	79445	3/4	5/300	45.38
47786	50036	79450	1	1/120	70.74
47787	50037	79465	1 1/4	1/100	125.45
47788	50038	79470	1 1/2	1/60	139.89
47789	50039	79475	2	1/40	237.00

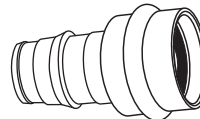

ADAPTATEURS EN LAITON PRF x EXP (F1960)					
#BMI	#Jungwoo	#Viega	Taille	Emballage	\$
47964	N/A	N/A	1/2	10/400	10.75
47965	N/A	N/A	3/4	10/300	16.10
47966	N/A	N/A	1	10/200	24.50

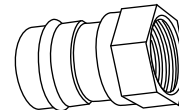

ADAPTATEURS EN LAITON PRF x F					
#BMI	#Jungwoo	#Viega	Taille	Emballage	\$
47754	N/A	N/A	1/2	10/300	11.68
47755	N/A	N/A	3/4	10/200	18.99
47756	N/A	N/A	1	10/160	34.98

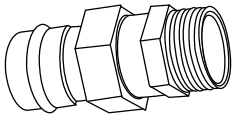

ADAPTATEURS OUVRÉS PRF x M					
#BMI	#Jungwoo	#Viega	Taille	Emballage	\$
47624	50303	79730	1/2	1/150	76.79
47625	50304	79735	3/4	1/70	82.33
47626	50305	79740	1	1/50	138.66
47627	50306	79745	1 1/4	1/50	250.95
47628	50307	79750	1 1/2	1/25	325.51
47629	50308	79755	2	1/20	371.86

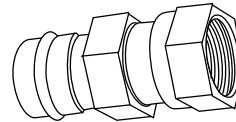

ADAPTATEURS OUVRÉS PRF x F					
#BMI	#Jungwoo	#Viega	Taille	Emballage	\$
47614	50297	79700	1/2	1/150	70.78
47615	50298	79705	3/4	1/70	82.59
47616	50299	79710	1	1/50	135.67
47617	50300	79715	1 1/4	1/50	143.58
47618	50301	79720	1 1/2	1/25	204.94
47619	50302	79725	2	1/20	323.05

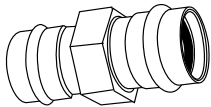

UNIONS OUVRÉS EN CUIVRE					
#BMI	#Jungwoo	#Viega	Taille	Emballage	\$
47104	50291	79125	1/2	1/150	61.66
47105	50292	79130	3/4	1/70	80.88
47106	50293	79135	1	1/50	129.55
47107	50294	79140	1 1/4	1/50	183.01
47108	50295	79145	1 1/2	1/25	250.93
47109	50296	79150	2	1/20	403.93

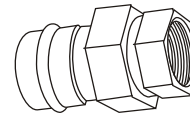

PRF x F UNIONS DIELECTRIC					
#BMI	#Jungwoo	#Viega	Taille	Emballage	\$
47194	N/A	79155	1/2	1/50	36.58
47195	N/A	79160	3/4	10/80	46.32
47196	N/A	79165	1	1/40	59.25
47197	N/A	79170	1 1/4	1/30	78.74
47198	N/A	79175	1 1/2	1/20	117.19
47199	N/A	79180	2	1/16	164.62



CAPUCHONS OUVRÉS EN CUIVRE					
#BMI	#Jungwoo	#Viega	Taille	Emballage	\$
47504	50049	77712	1/2	10/1000	12.78
47505	50050	77717	3/4	10/500	21.93
47506	50051	77722	1	5/300	33.84
47507	50052	77727	1 1/4	1/100	40.49
47508	50053	77732	1 1/2	1/90	62.76
47509	50054	77737	2	1/50	76.25
47510	50055	20833	2 1/2	1/30	248.04
47511	50056	20843	3	1/20	313.94
47512	50057	20848	4	1/15	366.05

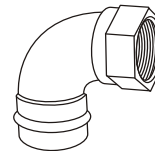

COUDES OUVRÉS 90° PRF x F					
#BMI	#Jungwoo	#Viega	Taille	Emballage	\$
47384	50076	79525	1/2	5/150	37.89
47385	50077	79540	3/4	5/100	60.42

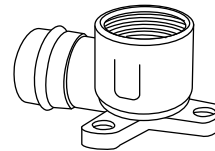

COUDES 90° PRF x F AVEC OREILLES EN LAITON SANS PLOMB					
#BMI	#Jungwoo	#Viega	Taille	Emballage	\$
47399	50082	79190	1/2	5/100	44.77
47398	50083	79195	3/4	5/50	92.53



JOINT TORIQUE PRF EN CAOUTCHOUC					
#BMI	#Jungwoo	#Viega	Taille	Emballage	\$
47974	40111	78242	1/2	10/50	6.36
47975	40112	78247	3/4	10/100	6.36
47976	40113	78252	1	5/200	7.45
47977	40114	78257	1 1/4	5/100	7.45
47978	40115	78262	1 1/2	5/100	10.56
47979	40116	78267	2	2/50	11.16

JOINT TORIQUE PRF AVEC PRÉHENSION EN ACIER INOX.					
#BMI	#Jungwoo	#Viega	Taille	Emballage	\$
47980	40117	N/A	2 1/2	1/25	46.38
47981	40118	N/A	3	1/25	54.49
47982	40119	N/A	4	1/25	64.17

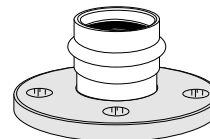

BRIDES COMPAGNONS #125 OUVRÉS					
#BMI	#Jungwoo	#Viega	Taille	Emballage	\$
47606	50309	79680	1 x 4 1/4	1/440	257.67
47607	50310	79685	1 1/4 x 4 5/8	1/12	374.36
47608	50311	79690	1 1/2 x 5	1/12	413.26
47609	50312	79695	2 x 6	1/6	464.27
47610	50313	20853	2 1/2 x 7	1/3	518.04
47611	50314	20858	3 x 7 1/2	1/3	627.85
47612	50315	20863	4 x 9	1/1	702.39

LISTE DE PRIX BMI CANADA - RACCORDS DE CUIVRE COULÉS TYPE PRESSION SANS PLOMB



CCF 26-1

9 mars 2026

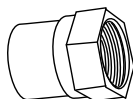

ADAPTATEURS C x F "CAST"			
BMI#	Taille	Emballage	\$
25704	1/2	25/600	125.10
25705	3/4	25/450	270.92
25706	1	25/200	514.05
25707	1 1/4	10/100	478.73
25708	1 1/2	10/90	663.52
25709	2	5/50	1 012.76

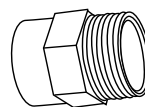

ADAPTATEURS C x M "CAST"			
BMI#	Taille	Emballage	\$
25804	1/2	25/600	108.35
25805	3/4	25/450	161.31
25806	1	25/250	270.88
25807	1 1/4	10/120	453.70
25808	1 1/2	10/100	538.41
25809	2	5/60	877.14

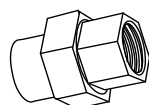

UNIONS C x F "HYBRIDE" (OUVRÉ /COULÉ)			
BMI#	Taille	Emballage	\$
25124	1/2	10/100	748.81
25125	3/4	5/75	942.11
25126	1	5/50	2 174.19
25127	1 1/4	2/30	3 913.32
25128	1 1/2	2/20	4 638.13

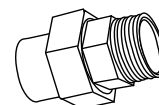

UNIONS C x M "HYBRIDE" (OUVRÉ /COULÉ)			
BMI#	Taille	Emballage	\$
25134	1/2	10/100	545.91
25135	3/4	5/75	821.24
25136	1	5/50	1 980.93
25137	1 1/4	2/30	2 608.80
25138	1 1/2	2/20	2 753.93
25139	2	1/15	5 556.04

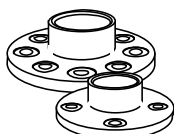

BRIDES COMPAGNONS #125 "CAST"			
BMI#	Taille	Emballage	\$
25606	1 x 4 1/4	1/30	1 582.56
25607	1 1/4 x 4 5/8	1/24	1 742.27
25608	1 1/2 x 5	1/20	2 100.31
25609	2 x 6	1/10	3 528.90
25610	2 1/2 x 7	1/10	4 887.89
25611	3 x 7 1/2	1/10	5 922.63
25612	4 x 9	1/5	9 738.50

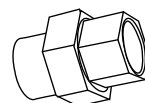

UNIONS C x C "HYBRIDE" (OUVRÉ /COULÉ)			
BMI#	Taille	Emballage	\$
25104	1/2	25/250	464.68
25105	3/4	25/200	674.82
25106	1	10/90	905.48
25107	1 1/4	5/45	1 271.01
25108	1 1/2	5/45	2 077.60
25109	2	1/33	3 092.13
25110	2 1/2	1/15	5 797.51
25111	3	1/12	14 010.83

BRIDES COMPAGNONS #150 "CAST"			
BMI#	Taille	Emballage	\$
25638	1 1/2 x 5	1/20	3 305.15
25639	2 x 6	1/10	4 444.34
25640	2 1/2 x 7	1/6	7 577.90
25641	3 x 7 1/2	1/5	8 419.73
25642	4 x 9	1/5	13 507.52

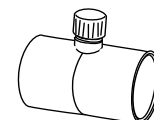

MANCHONS AVEC ÉVENT C x C "CAST"			
BMI#	Taille	Emballage	\$
25084	1/2	75/300	260.41

RACCORDS DE CUIVRE COULÉS TYPE PRESSION SANS PLOMB

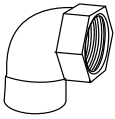

COUDES 90° C x F "CAST"			
BMI#	Taille	Emballage	\$
25384	1/2	25/300	166.76
25385	3/4	25/100	277.85
25386	1	25/75	821.24
COUDES 90° RÉDUITS C x F "CAST"			
25391	1/2 x 3/4	25/200	248.69
25392	1/2 x 3/8	25/200	222.38
25390	3/4 x 1/2	25/200	265.35



COUDES 90° C x F AVEC OREILLES "CAST"			
25399	1/2	25/200	217.60
25375	3/4	25/100	342.95
25377	1	20/120	1 159.37
COUDES 90° RÉDUITS C x F AVEC OREILLES "CAST"			
25376	1/2 x 3/8	25/200	342.95

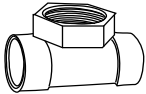

TÉS C x C x F "CAST"			
25591	1/2	25/150	192.72
25592	3/4	25/100	444.61
TÉS RÉDUITS C x C x F "CAST"			
25599	1/2 x 1/2 x 3/4	1/200	531.48
25593	3/4 x 3/4 x 1/2	25/200	439.67

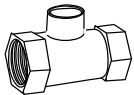

TÉS F x F x C "CAST"			
25586	3/4	25/100	532.84
TÉS RÉDUITS F x F x C "CAST"			
25589	3/4 x 1/2 x 1/2	25/100	284.95
25588	3/4 x 1/2 x 3/4	25/200	304.13
25587	3/4 x 3/4 x 1/2	25/100	403.49

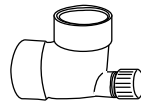

COUDES 90° AVEC ÉVENT "CAST"			
BMI#	Taille	Emballage	\$
25583	1/2	50/400	294.79
25584	3/4	25/150	450.95

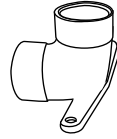

COUDES 90° C x C AVEC OREILLES "CAST"			
25360	1/2	25/300	183.49
25361	3/4	25/150	531.48

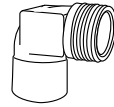

COUDES 90° C x M "CAST"			
25364	1/2	25/300	159.51
25365	3/4	25/200	318.75
25366	1	25/150	720.41
COUDES 90° RÉDUITS C x M "CAST"			
25367	3/4 x 1/2	25/200	410.62

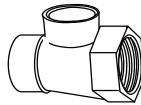

TÉS C x F x C "CAST"			
25595	1/2	25/150	205.02
25596	3/4	25/100	468.71
TÉS RÉDUITS C x F x C "CAST"			
25598	3/4 x 1/2 x 3/4	25/100	396.23

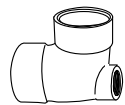

TÉS DE PLINTHE C x F x C "CAST"			
25579	1/2 x 1/8 x 1/2	25/400	246.28
25580	3/4 x 1/8 x 3/4	25/200	275.37
25581	1 x 1/8 x 1	25/100	729.35
25582	1 1/4 x 1/8 x 1 1/4	10/60	1 932.43

BRIDES DE CUIVRE COULÉS RÉGULIÈRES

NON CONÇU POUR L'EAU POTABLE

** LES BRIDES RÉGULIÈRES ONT UN ESCOMPTE DIFFÉRENT DES BRIDES SANS PLOMB

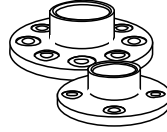
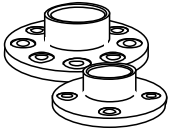

BRIDES COMPAGNONS #125 "CAST"			
21606	1 x 4 1/4	1/30	1 207.56
21607	1 1/4 x 4 5/8	1/24	1 568.44
21608	1 1/2 x 5	1/24	1 680.40
21609	2 x 6	5/10	2 658.40
21610	2 1/2 x 7	1/10	4 352.42
21611	3 x 7 1/2	1/8	4 485.13
21612	4 x 9	1/5	7 373.82

BRIDES COMPAGNONS #150 "CAST"			
-	1 x 4 1/4	-	-
-	1 1/4 x 4 5/8	-	-
21638	1 1/2 x 5	1/20	2 524.78
21639	2 x 6	1/10	3 381.99
21640	2 1/2 x 7	1/10	5 735.31
21641	3 x 7 1/2	1/5	6 428.59
21642	4 x 9	1/5	12 702.83

LISTE DE PRIX BMI CANADA - RACCORDS EN CUIVRE - DWV

DWV 26-1

9 mars 2026

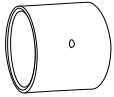

MANCHONS C x C DWV "OUVRÉS"			
#BMI	Taille	Emballage	\$
22007	1 1/4	10/300	104.26
22008	1 1/2	10/200	148.99
22009	2	10/100	226.00
22011	3	5/30	459.76
22012	4	1/20	1 998.78

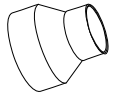

MANCHONS RÉDUITS C x C DWV "COULÉS"			
#BMI	Taille	Emballage	\$
22035	1 1/2 x 1 1/4	10/300	386.24
22041	2 x 1 1/4	10/150	670.85
22040	2 x 1 1/2	10/100	462.75
22053	3 x 1 1/2	5/50	1 199.48
22052	3 x 2	5/50	1 210.57

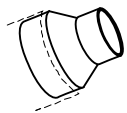

RÉDUCTEURS RACCORD x C DWV "COULÉS"			
#BMI	Taille	Emballage	\$
22135	1 1/2 x 1 1/4	10/300	463.38
22141	2 x 1 1/4	10/100	532.78
22140	2 x 1 1/2	10/150	455.93
22153	3 x 1 1/2	1/80	751.69
22152	3 x 2	5/100	1 166.00

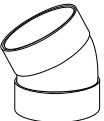

COUDES 45° C x C DWV "OUVRÉS"			
#BMI	Taille	Emballage	\$
22217	1 1/4	10/160	230.66
22218	1 1/2	10/100	322.91
22219	2	5/60	589.12
22221	3	1/18	1 377.02



COUDES 90° LONG RAYON CxC "OUVRÉS"			
#BMI	Taille	Emballage	\$
22378	1 1/2	5/100	758.68
22379	2	5/20	1 207.70



COUDES 45° RACCORD x C DWV "OUVRÉS"			
#BMI	Taille	Emballage	\$
22257	1 1/4	10/120	298.94
22258	1 1/2	10/100	371.62
22259	2	5/60	686.33
22261	3	1/18	1 752.35

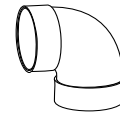

COUDES 90° C x C DWV "OUVRÉS"			
#BMI	Taille	Emballage	\$
22317	1 1/4	10/120	301.84
22318	1 1/2	10/80	415.71
22319	2	5/30	699.74
22321	3	1/12	1 925.78

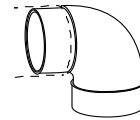

COUDES 90° RACCORD x C DWV "OUVRÉS"			
#BMI	Taille	Emballage	\$
22357	1 1/4	10/100	351.79
22358	1 1/2	10/80	478.17
22359	2	5/35	815.58
22361	3	1/1	1 713.51



COUDES 22- 1/2° C x C DWV "OUVRÉS"			
#BMI	Taille	Emballage	\$
22348	1 1/2	5/100	487.61
22349	2	5/80	820.01
22351	3	1/25	1354.77



COUDES 60° CxC DWV "OUVRÉS"			
#BMI	Taille	Emballage	\$
22367	1 1/4	10/100	407.55
22368	1 1/2	5/120	911.97
22369	2	5/80	1 202.58

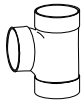

TÉS "Y" C x C x C DWV "OUVRÉS"			
#BMI	Taille	Emballage	\$
22407	1 1/4	5/70	596.11
22408	1 1/2	5/50	866.72
22409	2	1/30	1321.81
TÉS "Y" C x C x C DWV "COULÉS"			
22411	3	1/20	4926.69



TÉS "Y" RÉDUITS C x C x C DWV "COULÉS"			
22415	1 1/2 x 1 1/4 x 1 1/4	1/45	1 023.58
22414	1 1/2 x 1 1/4 x 1 1/2	1/80	833.13
22416	1 1/2 x 1 1/2 x 1 1/4	1/90	948.51
22425	2 x 1 1/4 x 1 1/2	1/50	1 721.84
22423	2 x 1 1/2 x 1 1/4	1/50	1 404.61
22422	2 x 1 1/2 x 1 1/2	1/50	1 245.93
22421	2 x 1 1/2 x 2	1/30	1 691.89
22420	2 x 2 x 1 1/4	1/40	1 306.33
22419	2 x 2 x 1 1/2	1/40	958.96
22440	3 x 1 1/2 x 1 1/4	1/36	2 109.54
22430	3 x 3 x 1 1/4	1/20	3 142.24
22429	3 x 3 x 1 1/2	1/30	2 766.29
22428	3 x 3 x 2	1/20	3 653.81

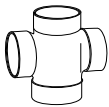

TÉS "Y" DOUBLES C x C x C x C DWV "COULÉS"			
22457	1 1/4	1/50	1 484.40
22458	1 1/2	1/30	1 998.06
22459	2	1/20	2 758.31
TÉS "Y" DOUBLES RÉDUITS DWV "COULÉS"			
22463	1 1/2 x 1 1/4	1/50	1 580.40
22466	2 x 1 1/4	1/25	1 857.72
22465	2 x 1 1/2	1/25	1 560.57

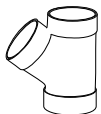

"Y" C x C x C DWV "COULÉS"			
22507	1 1/4	10/70	1 050.92
22508	1 1/2	5/60	1 313.63
22509	2	5/50	2 145.58
22511	3	1/12	6 470.36



"Y" RÉDUITS C x C x C DWV "COULÉS"			
#BMI	Taille	Emballage	\$
22515	1 1/2 x 1 1/4 x 1 1/4	1/45	1 281.99
22514	1 1/2 x 1 1/4 x 1 1/2	1/80	1 726.43
22516	1 1/2 x 1 1/2 x 1 1/4	1/80	1 036.00
22522	2 x 1 1/2 x 1 1/2	1/50	1 624.84
22521	2 x 1 1/2 x 2	1/40	2 597.09
22520	2 x 2 x 1 1/4	1/50	2 092.68
22519	2 x 2 x 1 1/2	1/50	1 678.53
22528	3 x 3 x 1 1/2	1/30	2 999.75
22527	3 x 3 x 2	1/20	3 888.63

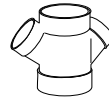

"Y" DOUBLES C x C x C x C DWV "COULÉS"			
22557	1 1/4	1/50	1 760.96
22558	1 1/2	1/35	1 636.50
22559	2	1/25	3 020.04
"Y" DOUBLES RÉDUITS DWV "COULÉS"			
22565	2 x 1 1/2	5/40	2 611.17

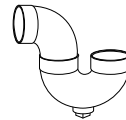

SIPHONS-P AVEC VIDANGE DWV "COULÉS"			
22667	1 1/4	1/30	2 659.29
22668	1 1/2	1/25	2 177.10
22669	2	1/20	4 138.80



SIPHONS-P SANS VIDANGE DWV "COULÉS"			
22677	1 1/4	1/30	2 437.75
22678	1 1/2	1/25	1 817.56
22679	2	1/20	4 082.17

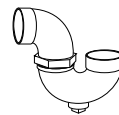

SIPHONS-P AJUST. AVEC VIDANGE "COULÉS"			
22698	1 1/2	1/25	2 688.13



ADAPTATEURS C x F DWV "COULÉS"

#BMI	Taille	Emballage	\$
22707	1 1/4	5/200	643.37
22708	1 1/2	10/150	634.67
22709	2	5/90	757.22
22711	3	1/25	3 238.33



ADAPTATEURS C x M DWV "COULÉS"

22807	1 1/4	10/300	380.12
22808	1 1/2	10/200	447.22
22809	2	10/150	827.67
22811	3	5/30	2 596.70



ADAPTATEURS C x JM DWV "COULÉS"

22854	1 1/2 x 2	5/100	871.26
22855	2 x 2	1/200	399.75

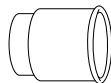

VIROLES x TUYAU EN FONTE DWV "COULÉS"

22844	1 1/2 x 2	10/200	1 574.18
-------	-----------	--------	----------

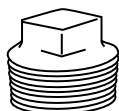

BOUCHONS DWV "COULÉ"

22907	1 1/4 (pour 22607 & 22617)	1/1	276.46
22908	1 1/2 (pour 22608 & 22618)	1/1	393.61
22909	2 (pour 22609 & 22619)	1/1	573.86
22911	3 (pour 22611 & 22620)	1/1	580.21



REGARDS DE VIDANGE RACC. DWV "COULÉS"

#BMI	Taille	Emballage	\$
22607	1 1/4	2/120	995.80
22608	1 1/2	5/100	839.83
22609	2	5/60	1 342.82
22611	3	1/20	4 222.23



REGARDS À FLEUR DWV "COULÉS"

22658	1 1/2 x 1	5/120	439.05
22659	2 x 1 1/2	5/75	493.02
22661	3 x 2 1/2	2/30	1 279.17

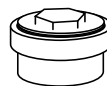

REGARDS DE VIDANGE DWV "COULÉ"

22717	1 1/4	1/1	1 358.55
22718	1 1/2	1/100	1 050.84
22719	2	5/80	1 451.55
22721	3	1/1	5 801.11

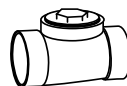

LIGNES DE REGARD C x C DWV "COULÉS"

22617	1 1/4	1/50	1 368.36
22618	1 1/2	5/50	1 314.22
22619	2	5/40	2 446.57



BRIDES DE TOILETTE (à souder) DWV "COULÉS"

22651	4 x 3	5/50	1 411.66
-------	-------	------	----------

Pour ces adaptateurs coulissants, veuillez vous référer à cette liste:

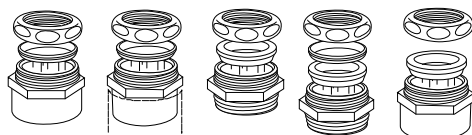



LISTE DE PRIX BMI CANADA RACCORDS CUIVRÉS OUVRÉS - TYPE PRESSION

**CWR
26-1**

9 mars 2026

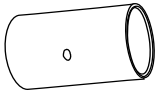

MANCHONS OUVRÉS C x C			
#BMI	Taille	Emballage	\$
37001	1/8	25/5000	11.90
37002	1/4	25/2000	10.21
37003	3/8	25/1200	14.35
37004	1/2	25/800	13.65
37013	5/8	25/400	31.91
37005	3/4	25/300	29.57
37006	1	10/150	66.16
37007	1 1/4	1/80	77.45
37008	1 1/2	1/60	123.91
37009	2	1/40	238.52
37010	2 1/2	1/25	365.04
37011	3	1/12	585.81
37012	4	1/5	1 190.93
37017	6	1/3	5 688.04

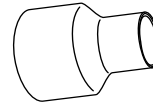

MANCHONS OUVRÉS RÉDUITS C x C			
#BMI	Taille	Emballage	\$
37015	1/4 x 1/8	25/2000	78.13
37016	3/8 x 1/4	25/400	75.58
37021	1/2 x 1/8	25/1000	47.20
37020	1/2 x 1/4	25/800	32.88
37019	1/2 x 3/8	25/800	32.88
37022	5/8 x 3/8	25/600	84.28
37018	5/8 x 1/2	25/500	80.91
37025	3/4 x 1/4	25/400	92.36
37024	3/4 x 3/8	25/400	98.96
37023	3/4 x 1/2	25/350	33.64
37062	3/4 x 5/8	25/350	41.11
37028	1 x 1/2	10/200	92.38
37063	1 x 5/8	10/200	184.78
37027	1 x 3/4	10/160	65.57
37033	1 1/4 x 1/2	1/100	195.63
37032	1 1/4 x 3/4	1/100	148.64
37031	1 1/4 x 1	1/100	109.73
37038	1 1/2 x 1/2	1/100	267.27
37037	1 1/2 x 3/4	1/100	203.02
37036	1 1/2 x 1	1/100	236.49
37035	1 1/2 x 1 1/4	1/70	162.76
37044	2 x 1/2	1/30	342.80
37043	2 x 3/4	1/50	319.24
37042	2 x 1	1/50	311.55
37041	2 x 1 1/4	1/50	252.09
37040	2 x 1 1/2	1/50	252.09
37049	2 1/2 x 1	1/30	585.98
37047	2 1/2 x 1 1/2	1/30	558.01
37046	2 1/2 x 2	1/30	558.01
37053	3 x 1 1/2	1/20	697.28
37052	3 x 2	1/20	697.28
37051	3 x 2 1/2	1/15	697.28
37058	4 x 2	1/6	1 721.48
37057	4 x 2 1/2	1/6	1 721.48
37056	4 x 3	1/18	1 721.48
37066	6 x 3	1/3	6 722.28
37065	6 x 4	1/1	9 903.26



MANCHONS OUVRÉS C x C SANS ARRÊT			
#BMI	Taille	Emballage	\$
37074	1/2	25/800	15.74
37075	3/4	25/300	36.04
37076	1	10/150	70.70
37077	1 1/4	1/100	98.59
37078	1 1/2	1/60	147.34
37079	2	1/40	261.64
37080	2 1/2	1/50	412.99

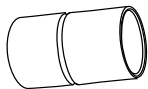

MANCHONS OUVRÉS C x C AVEC ARRÊT			
#BMI	Taille	Emballage	\$
37091	1/8	25/5000	18.58
37082	1/4	25/2000	19.01
37083	3/8	25/1200	16.08
37084	1/2	25/800	16.08
37093	5/8	25/400	30.41
37085	3/4	25/300	36.04
37086	1	10/150	71.35
37087	1 1/4	1/100	98.57
37088	1 1/2	1/60	148.48
37089	2	1/40	269.23

RACCORDS CUIVRÉS OUVRÉS - TYPE PRESSION

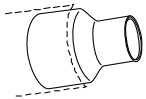

RÉDUCTEURS OUVRÉS RACCORD x C			
#BMI	Taille	Emballage	\$
37116	3/8 x 1/4	25/1200	47.05
37120	1/2 x 1/4	25/1000	27.73
37119	1/2 x 3/8	25/1000	27.73
37123	3/4 x 1/2	25/400	33.49
37162	3/4 x 5/8	25/400	58.16
37128	1 x 1/2	10/200	87.52
37163	1 x 5/8	10/170	182.44
37127	1 x 3/4	10/160	61.80
37133	1 1/4 x 1/2	1/100	182.44
37132	1 1/4 x 3/4	1/100	141.89
37131	1 1/4 x 1	1/100	114.43
37138	1 1/2 x 1/2	1/100	230.83
37137	1 1/2 x 3/4	1/100	186.32
37136	1 1/2 x 1	1/100	186.32
37135	1 1/2 x 1 1/4	1/70	152.00
37144	2 x 1/2	1/50	307.58
37143	2 x 3/4	1/50	320.15
37142	2 x 1	1/50	286.65
37141	2 x 1 1/4	1/50	262.88
37140	2 x 1 1/2	1/50	262.88
37149	2 1/2 x 1	1/30	523.56
37148	2 1/2 x 1 1/4	1/30	523.56
37147	2 1/2 x 1 1/2	1/30	523.56
37146	2 1/2 x 2	1/30	523.56
37154	3 x 1 1/4	1/20	767.74
37153	3 x 1 1/2	1/20	696.88
37152	3 x 2	1/20	679.17
37151	3 x 2 1/2	1/15	679.17
37158	4 x 2	1/20	1 460.12
37157	4 x 2 1/2	1/6	1 587.08
37156	4 x 3	1/6	1 460.12
37166	6 x 3	1/4	14 735.82

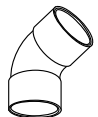

COUDES OUVRÉS 45° C x C			
#BMI	Taille	Emballage	\$
37201	1/8	25/2000	174.65
37202	1/4	25/1200	99.49
37203	3/8	25/800	98.81
37204	1/2	25/500	28.51
37213	5/8	25/300	128.28
37205	3/4	25/200	49.75
37206	1	10/100	108.24
37207	1 1/4	1/60	153.11
37208	1 1/2	1/40	219.63
37209	2	1/18	359.36
37210	2 1/2	1/20	912.82
37211	3	1/12	1 329.47
37212	4	1/3	2 677.06
37214	6	1/2	12 711.00

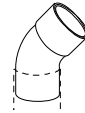

COUDES OUVRÉS 45° RACCORD x C			
#BMI	Taille	Emballage	\$
37252	1/4	25/1200	125.43
37254	1/2	25/500	28.99
37282	5/8	25/300	232.73
37255	3/4	25/200	51.12
37256	1	10/100	149.47
37257	1 1/4	1/60	196.22
37258	1 1/2	1/40	255.60
37259	2	1/18	429.41
37260	2 1/2	1/20	1 214.40
37261	3	1/15	1 582.56
37262	4	1/3	7 305.50

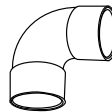

COUDES OUVRÉS 90° C x C			
#BMI	Taille	Emballage	\$
37301	1/8	25/3450	74.47
37302	1/4	25/1200	49.73
37303	3/8	25/1000	45.66
37304	1/2	25/500	20.25
37313	5/8	25/300	101.82
37305	3/4	25/200	47.73
37306	1	10/100	87.42
37307	1 1/4	1/50	140.99
37308	1 1/2	1/35	224.32
37309	2	1/18	399.57
37310	2 1/2	1/10	1 137.72
37311	3	1/13	1 521.23
37312	4	1/2	3 234.20
37317	6	1/1	13 703.40

COUDES 90° RÉDUIT Cx C			
#BMI	Taille	Emballage	\$
37319	1/2 x 3/8	25/500	211.47
37323	3/4 x 1/2	25/200	76.64
37328	1 x 1/2	10/80	226.94
37327	1 x 3/4	10/80	149.47
37332	1 1/4 x 3/4	20/120	413.93

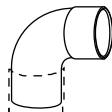

COUDES OUVRÉS 90° RACCORD x C			
#BMI	Taille	Emballage	\$
37342	1/4	25/800	82.89
37353	3/8	25/800	60.93
37354	1/2	25/500	27.80
37382	5/8	25/300	105.06
37355	3/4	25/200	51.35
37356	1	10/100	107.92
37357	1 1/4	1/50	260.67
37358	1 1/2	1/35	301.44
37359	2	1/17	510.61
37360	2 1/2	1/20	1 167.10
37361	3	1/6	1 678.62
37362	4	1/6	3 780.58

RACCORDS CUIVRÉS OUVRÉS - TYPE PRESSION

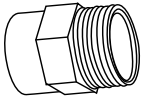

ADAPTATEURS OUVRÉS C x M			
#BMI	Taille	Emballage	\$
37803	3/8	25/1000	156.22
37804	1/2	25/600	58.08
37805	3/4	25/250	83.65
37806	1	10/150	182.24
37807	1 1/4	1/80	251.79
37808	1 1/2	1/65	326.89
37809	2	1/38	471.91
37810	2 1/2	1/48	1 585.77
37811	3	1/36	1 883.04
37812	4	1/12	4 130.18

ADAPTATEURS OUVRÉS RÉDUITS C x M			
#BMI	Taille	Emballage	\$
37817	3/8 x 1/2	25/500	142.49
37826	1/2 x 1/4	25/1000	114.05
37818	1/2 x 3/8	25/800	114.05
37822	1/2 x 3/4	25/250	126.17
37821	1/2 x 1	10/150	263.13
37823	3/4 x 1/2	25/250	162.54
37827	3/4 x 1	10/150	198.41
37832	1 x 1/2	10/180	320.60
37833	1 x 3/4	10/150	313.26
37831	1 x 1 1/4	1/85	488.37
37830	1 x 1 1/2	1/95	526.27
37837	1 1/4 x 3/4	1/120	365.03
37836	1 1/4 x 1	1/120	315.01
37835	1 1/4 x 1 1/2	1/90	546.74
37840	1 1/2 x 1	1/120	717.86
37839	1 1/2 x 1 1/4	1/60	437.38
37842	1 1/2 x 2	1/55	820.86

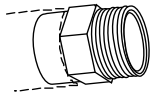

ADAPTATEURS OUVRÉS RACCORD x M			
#BMI	Taille	Emballage	\$
37884	1/2	25/500	129.59
37885	3/4	25/250	193.30
37886	1	10/130	223.57
37887	1 1/4	10/80	700.19
37888	1 1/2	1/80	795.00
37889	2	1/38	1 370.31

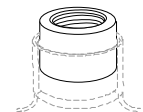

RACCORDS x FIPS DOUILLE À FLEUR OUVRÉS			
#BMI	Taille	Emballage	\$
37170	1/2 x 1/8	25/1000	87.30
37169	1/2 x 1/4	25/1000	87.30

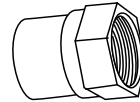

ADAPTATEURS OUVRÉS C x F			
#BMI	Taille	Emballage	\$
37702	1/4	25/1500	134.01
37703	3/8	25/800	99.34
37704	1/2	25/450	68.83
37705	3/4	25/200	135.96
37706	1	10/140	214.53
37707	1 1/4	1/80	384.93
37708	1 1/2	1/60	422.28
37709	2	1/30	586.91
37710	2 1/2	1/24	1 962.83
37711	3	1/28	2 831.74

ADAPTATEURS OUVRÉS RÉDUITS C x F			
#BMI	Taille	Emballage	\$
37719	1/2 x 1/4	25/800	96.66
37718	1/2 x 3/8	25/800	111.15
37717	1/2 x 3/4	25/300	146.13
37723	3/4 x 1/2	25/300	144.37
37722	3/4 x 1	10/140	233.09
37728	1 x 1/2	10/150	352.13
37727	1 x 3/4	10/150	240.89
37726	1 x 1 1/4	1/85	416.54
37734	1 1/4 x 3/4	1/120	468.71
37733	1 1/4 x 1	1/120	533.49
37732	1 1/4 x 1 1/2	1/100	560.63
37736	1 1/2 x 1 1/4	1/70	536.50
37742	1 1/2 x 2	1/60	892.62

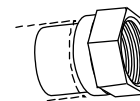

ADAPTATEURS OUVRÉS RACCORD x F			
#BMI	Taille	Emballage	\$
37784	1/2	25/500	132.94
37785	3/4	25/250	153.81
37786	1	10/140	235.42
37787	1 1/4	1/85	402.01
37788	1 1/2	1/80	604.66
37789	2	1/40	770.02
37791	3/4 x 1/2	25/250	161.12

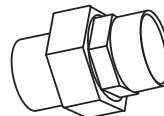

**Maintenant en
cuivre ouvré!**

UNIONS OUVRÉS C x C			
#BMI	Taille	Emballage	\$
37104	1/2	25/250	177.55
37105	3/4	25/100	354.12
37106	1	10/60	497.57
37107	1 1/4	5/45	737.79
37108	1 1/2	5/25	1 039.13
37109	2	1/24	1 679.54

RACCORDS CUIVRÉS OUVRÉS - TYPE PRESSION

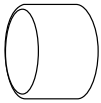

CAPUCHONS OUVRÉS EN CUIVRE			
#BMI	Taille	Emballage	\$
37502	1/4	25/2000	19.03
37503	3/8	25/1500	27.85
37504	1/2	25/1400	11.82
37513	5/8	25/850	34.88
37505	3/4	25/500	27.46
37506	1	10/300	64.01
37507	1 1/4	1/160	89.53
37508	1 1/2	1/140	130.08
37509	2	1/60	233.09
37510	2 1/2	1/50	650.19
37511	3	1/30	886.59
37512	4	1/25	1 660.06

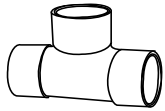

TÉS OUVRÉS CCC			
37401	1/8	25/2000	137.13
37402	1/4	25/1300	137.13
37403	3/8	25/600	102.14
37404	1/2	25/300	37.08
37413	5/8	25/200	206.55
37405	3/4	10/120	80.94
37406	1	10/60	172.91
37407	1 1/4	1/35	247.78
37408	1 1/2	1/20	372.28
37409	2	1/10	658.02
37410	2 1/2	1/15	1 238.92
37411	3	1/10	2 220.02
37412	4	1/2	4 367.30
37414	6	1/1	19 536.26

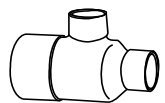

TÉS OUVRÉS RÉDUITS CCC			
3/8", 1/2", 3/4"			
37417	3/8 x 3/8 x 1/4	25/600	236.97
37421	1/2 x 1/2 x 3/8	25/400	186.82
37420	1/2 x 1/2 x 3/4	10/180	130.57
37419	1/2 x 1/2 x 1	10/70	358.80
37431	3/4 x 1/2 x 1/2	10/180	104.26
37430	3/4 x 1/2 x 3/4	10/120	107.84
37429	3/4 x 3/4 x 1/2	10/170	109.93
37428	3/4 x 3/4 x 1	10/80	293.74
1"			
37450	1 x 1/2 x 1/2	10/100	247.92
37449	1 x 1/2 x 3/4	10/80	247.88
37448	1 x 1/2 x 1	10/60	235.42

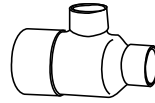

TÉS OUVRÉS RÉDUITS CCC			
1"			
37445	1 x 3/4 x 1/2	10/60	235.42
37443	1 x 3/4 x 3/4	10/60	235.42
37442	1 x 3/4 x 1	10/60	235.42
37439	1 x 1 x 1/2	10/100	172.57
37438	1 x 1 x 3/4	10/60	172.57
37437	1 x 1 x 1 1/4	1/35	436.49
37436	1 x 1 x 1 1/2	1/25	982.88
1 1/4"			
37465	1 1/4 x 1/2 x 1 1/4	1/35	423.19
37463	1 1/4 x 3/4 x 3/4	1/50	353.36
37462	1 1/4 x 3/4 x 1	1/45	375.91
37461	1 1/4 x 3/4 x 1 1/4	1/35	423.21
37460	1 1/4 x 1 x 1/2	1/60	353.36
37459	1 1/4 x 1 x 3/4	1/50	353.36
37458	1 1/4 x 1 x 1	1/50	353.36
37457	1 1/4 x 1 x 1 1/4	1/30	353.36
37455	1 1/4 x 1 1/4 x 1/2	1/50	249.92
37454	1 1/4 x 1 1/4 x 3/4	1/50	249.92
37453	1 1/4 x 1 1/4 x 1	1/40	249.92
37451	1 1/4 x 1 1/4 x 1 1/2	1/20	609.75
1 1/2"			
37490	1 1/2 x 1/2 x 1 1/2	1/20	573.08
37489	1 1/2 x 3/4 x 1/2	1/40	650.16
37488	1 1/2 x 3/4 x 3/4	1/40	560.13
37487	1 1/2 x 3/4 x 1	1/40	560.13
37485	1 1/2 x 3/4 x 1 1/4	1/30	600.15
37486	1 1/2 x 3/4 x 1 1/2	1/20	560.13
37484	1 1/2 x 1 x 1/2	1/40	590.15
37483	1 1/2 x 1 x 3/4	1/30	560.13
37482	1 1/2 x 1 x 1	1/35	560.13
37481	1 1/2 x 1 x 1 1/4	1/20	575.15
37480	1 1/2 x 1 x 1 1/2	1/20	560.13
37479	1 1/2 x 1 1/4 x 1/2	1/40	560.13
37478	1 1/2 x 1 1/4 x 3/4	1/40	560.13
37477	1 1/2 x 1 1/4 x 1	1/30	560.13
37476	1 1/2 x 1 1/4 x 1 1/4	1/30	560.13
37475	1 1/2 x 1 1/4 x 1 1/2	1/20	560.13
37474	1 1/2 x 1 1/2 x 1/2	1/40	362.81
37473	1 1/2 x 1 1/2 x 3/4	1/35	345.32
37472	1 1/2 x 1 1/2 x 1	1/35	373.91
37471	1 1/2 x 1 1/2 x 1 1/4	1/25	392.32
37470	1 1/2 x 1 1/2 x 2	1/10	1 088.89
2"			
37532	2 x 1/2 x 2	1/15	1 089.57
37529	2 x 3/4 x 2	1/10	1 089.57
37527	2 x 1 x 1	1/20	1 225.83
37525	2 x 1 x 2	1/15	1 228.15
37524	2 x 1 1/4 x 1	1/20	870.49
37523	2 x 1 1/4 x 1 1/4	1/15	835.67
37522	2 x 1 1/4 x 2	1/10	982.91

RACCORDS CUIVRÉS OUVRÉS - TYPE PRESSION

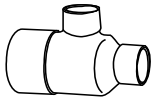

TÉS OUVRÉS RÉDUITS CCC			
#BMI	Taille	Emballage	\$
2"			
37520	2 x 1 1/2 x 3/4	1/20	1 000.28
37519	2 x 1 1/2 x 1	1/20	796.42
37518	2 x 1 1/2 x 1 1/4	1/10	796.42
37517	2 x 1 1/2 x 1 1/2	1/10	796.42
37516	2 x 1 1/2 x 2	1/10	817.33
37498	2 x 2 x 1/2	1/20	606.17
37497	2 x 2 x 3/4	1/20	621.98
37496	2 x 2 x 1	1/18	665.77
37495	2 x 2 x 1 1/4	1/15	690.06
37491	2 x 2 x 1 1/2	1/10	717.37
2 1/2"			
37545	2 1/2 x 1 1/2 x 1 1/2	1/10	2 479.87
37544	2 1/2 x 1 1/2 x 2 1/2	1/20	2 064.03
37542	2 1/2 x 2 x 1 1/2	1/10	2 010.18
37541	2 1/2 x 2 x 2	1/8	2 010.18
37540	2 1/2 x 2 x 2 1/2	1/15	2 010.18
37539	2 1/2 x 2 1/2 x 1/2	1/25	1 387.04
37538	2 1/2 x 2 1/2 x 3/4	1/25	1 387.04
37537	2 1/2 x 2 1/2 x 1	1/25	1 387.04
37536	2 1/2 x 2 1/2 x 1 1/4	1/20	1 387.04
37535	2 1/2 x 2 1/2 x 1 1/2	1/20	1 387.04
37534	2 1/2 x 2 1/2 x 2	1/8	1 387.04

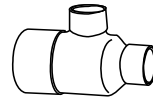

TÉS OUVRÉS RÉDUITS CCC			
#BMI	Taille	Emballage	\$
3"			
37560	3 x 2 x 2	1/15	2 479.87
37561	3 x 2 1/2 x 2	1/6	2 750.09
37562	3 x 2 1/2 x 2 1/2	1/15	2 750.09
37555	3 x 3 x 1/2	1/10	2 133.73
37554	3 x 3 x 3/4	1/20	2 133.73
37553	3 x 3 x 1	1/20	2 234.80
37552	3 x 3 x 1 1/4	1/15	2 234.80
37551	3 x 3 x 1 1/2	1/6	2 234.80
37550	3 x 3 x 2	1/13	2 234.80
37549	3 x 3 x 2 1/2	1/10	2 424.55
4", 6"			
37579	4 x 3 x 3	1/5	6 235.32
37576	4 x 4 x 3/4	1/8	4 601.93
37575	4 x 4 x 1	1/8	5 264.93
37574	4 x 4 x 1 1/4	1/8	4 367.94
37573	4 x 4 x 1 1/2	1/8	4 367.94
37572	4 x 4 x 2	1/6	4 367.94
37571	4 x 4 x 2 1/2	1/5	4 367.94
37570	4 x 4 x 3	1/2	4 670.55
37669	6 x 6 x 4	1/2	18 570.87



COUDES LONG RAYON CxC 90°			
37901	1/8	25/2000	132.70
37902	1/4	25/1200	65.98
37903	3/8	25/650	79.06
37904	1/2	25/350	70.91
37913	5/8	25/200	71.85
37905	3/4	10/120	89.16
37906	1	10/70	172.49
37907	1 1/4	1/35	299.23
37908	1 1/2	1/25	461.55
37909	2	1/12	788.57

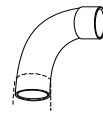

COUDES LONG RAYON RAC. x 90°			
37951	1/8	25/2000	186.77
37952	1/4	25/1200	83.19
37953	3/8	25/750	154.76
37954	1/2	25/350	103.12
37963	5/8	25/200	121.93
37955	3/4	10/120	123.13
37956	1	10/60	199.96
37957	1 1/4	1/35	295.12
37958	1 1/2	1/25	555.61
37959	2	1/12	799.34



**LISTE DE PRIX BMI CANADA RACCORDS
DE CUIVRE ACR - RÉFRIGÉRATION**

**ACR
26-1**

9 mars 2026

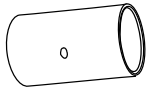

MANCHONS OUVRÉS C x C (O.D.)			
# BMI	Taille O.D.	Emballage	\$
37001	1/4	25/5000	11.90
37002	3/8	25/2000	10.21
37003	1/2	25/1200	14.35
37004	5/8	25/800	13.65
37013	3/4	25/400	31.91
37005	7/8	25/300	29.57
37006	1 1/8	10/150	66.16
37007	1 3/8	1/80	77.45
37008	1 5/8	1/60	123.91
37009	2 1/8	1/40	238.52
37010	2 5/8	1/25	365.04
37011	3 1/8	1/12	585.81
37012	4 1/8	1/5	1 190.93
37017	6 1/8	1/3	5 688.04

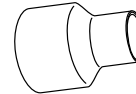

MANCHONS OUVRÉS RÉDUITS C x C (O.D.)			
# BMI	Taille O.D.	Emballage	\$
37015	3/8 x 1/4	25/2000	78.13
37016	1/2 x 3/8	25/400	75.58
37021	5/8 x 1/4	25/1000	47.20
37020	5/8 x 3/8	25/800	32.88
37019	5/8 x 1/2	25/800	32.88
37022	3/4 x 1/2	25/600	84.28
37018	3/4 x 5/8	25/500	80.91
37025	7/8 x 3/8	25/400	92.36
37024	7/8 x 1/2	25/400	98.96
37023	7/8 x 5/8	25/350	33.64
37062	7/8 x 3/4	25/350	41.11
37028	1 1/8 x 5/8	10/200	92.38
37063	1 1/8 x 3/4	10/200	184.78
37027	1 1/8 x 7/8	10/160	65.57
37033	1 3/8 x 5/8	1/100	195.63
37032	1 3/8 x 7/8	1/100	148.64
37031	1 3/8 x 1 1/8	1/100	109.73
37038	1 5/8 x 5/8	1/100	267.27
37037	1 5/8 x 7/8	1/100	203.02
37036	1 5/8 x 1 1/8	1/100	236.49
37035	1 5/8 x 1 3/8	1/70	162.76
37044	2 1/8 x 5/8	1/30	342.80
37043	2 1/8 x 7/8	1/50	319.24
37042	2 1/8 x 1 1/8	1/50	311.55
37041	2 1/8 x 1 3/8	1/50	252.09
37040	2 1/8 x 1 5/8	1/50	252.09
37049	2 5/8 x 1 1/8	1/30	585.98
37047	2 5/8 x 1 5/8	1/30	558.01
37046	2 5/8 x 2 1/8	1/30	558.01
37053	3 1/8 x 1 5/8	1/20	697.28
37052	3 1/8 x 2 1/8	1/20	697.28
37051	3 1/8 x 2 5/8	1/15	697.28
37058	4 1/8 x 2 1/8	1/6	1 721.48
37057	4 1/8 x 2 5/8	1/6	1 721.48
37056	4 1/8 x 3 1/8	1/18	1 721.48
37066	6 1/8 X 3 1/8	1/3	6 722.28
37065	6 1/8 X 4 1/8	1/1	9 903.26



MANCHONS OUVRÉS SANS ARRET C x C (O.D.)			
# BMI	Taille O.D.	Emballage	\$
37074	5/8	25/800	15.74
37075	7/8	25/300	36.04
37076	1 1/8	10/150	70.70
37077	1 3/8	1/100	98.59
37078	1 5/8	1/60	147.34
37079	2 1/8	1/40	261.64
37080	2 5/8	1/50	412.99

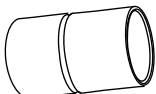

MANCHONS OUVRÉS AVEC ARRET C x C (O.D.)			
# BMI	Taille O.D.	Emballage	\$
37091	1/4	25/5000	18.58
37082	3/8	25/2000	19.01
37083	1/2	25/1200	16.08
37084	5/8	25/800	16.08
37093	3/4	25/400	30.41
37085	7/8	25/300	36.04
37086	1 1/8	10/150	71.35
37087	1 3/8	1/100	98.57
37088	1 5/8	1/60	148.48
37089	2 1/8	1/40	269.23

** O.D. : Diamètre extérieur

RACCORDS DE CUIVRE ACR - RÉFRIGÉRATION

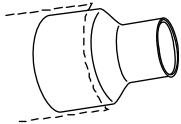

RÉDUCTEURS OUVRÉS RAC. x C (O.D.)			
# BMI	Taille O.D.	Emballage	\$
37116	1/2 x 3/8	25/1200	47.05
37120	5/8 x 3/8	25/1000	27.73
37119	5/8 x 1/2	25/1000	27.73
37123	7/8 x 5/8	25/400	33.49
37162	7/8 x 3/4	25/400	58.16
37128	1 1/8 x 5/8	10/200	87.52
37163	1 1/8 x 3/4	10/170	182.44
37127	1 1/8 x 7/8	10/160	61.80
37133	1 3/8 x 5/8	1/100	182.44
37132	1 3/8 x 7/8	1/100	141.89
37131	1 3/8 x 1 1/8	1/100	114.43
37138	1 5/8 x 5/8	1/100	230.83
37137	1 5/8 x 7/8	1/100	186.32
37136	1 5/8 x 1 1/8	1/100	186.32
37135	1 5/8 x 1 3/8	1/70	152.00
37144	2 1/8 x 5/8	1/50	307.58
37143	2 1/8 x 7/8	1/50	320.15
37142	2 1/8 x 1 1/8	1/50	286.65
37141	2 1/8 x 1 3/8	1/50	262.88
37140	2 1/8 x 1 5/8	1/50	262.88
37149	2 5/8 x 1 1/8	1/30	523.56
37148	2 5/8 x 1 3/8	1/30	523.56
37147	2 5/8 x 1 5/8	1/30	523.56
37146	2 5/8 x 2 1/8	1/30	523.56
37154	3 1/8 x 1 3/8	1/20	767.74
37153	3 1/8 x 1 5/8	1/20	696.88
37152	3 1/8 x 2 1/8	1/20	679.17
37151	3 1/8 x 2 5/8	1/15	679.17
37158	4 1/8 x 2 1/8	1/20	1 460.12
37157	4 1/8 x 2 5/8	1/6	1 587.08
37156	4 1/8 x 3 1/8	1/6	1 460.12
37166	6 1/8 x 3 1/8	1/4	14 735.82



COUDES OUVRÉS 45° Cx C (O.D.)			
# BMI	Taille O.D.	Emballage	\$
37201	1/4	25/2000	174.65
37202	3/8	25/1200	99.49
37203	1/2	25/800	98.81
37204	5/8	25/500	28.51
37213	3/4	25/300	128.28
37205	7/8	25/200	49.75
37206	1 1/8	10/100	108.24
37207	1 3/8	1/60	153.11
37208	1 5/8	1/40	219.63
37209	2 1/8	1/18	359.36
37210	2 5/8	1/20	912.82
37211	3 1/8	1/12	1 329.47
37212	4 1/8	1/3	2 677.06
37214	6 1/8	1/2	12 711.00

** O.D. : Diamètre extérieur

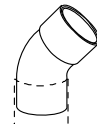

COUDES OUVRÉS 45° RACCORD x C (O.D.)			
# BMI	Taille O.D.	Emballage	\$
37252	3/8	25/1200	125.43
37254	5/8	25/500	28.99
37282	3/4	25/300	232.73
37255	7/8	25/200	51.12
37256	1 1/8	10/100	149.47
37257	1 3/8	1/60	196.22
37258	1 5/8	1/40	255.60
37259	2 1/8	1/18	429.41
37260	2 5/8	1/20	1 214.40
37261	3 1/8	1/15	1 582.56
37262	4 1/8	1/3	7 305.50

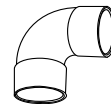

COUDES OUVRÉS 90° C x C (O.D.)			
# BMI	Taille O.D.	Emballage	\$
37301	1/4	25/3450	74.47
37302	3/8	25/1200	49.73
37303	1/2	25/1000	45.66
37304	5/8	25/500	20.25
37313	3/4	25/300	101.82
37305	7/8	25/200	47.73
37306	1 1/8	10/100	87.42
37307	1 3/8	1/50	140.99
37308	1 5/8	1/35	224.32
37309	2 1/8	1/18	399.57
37310	2 5/8	1/10	1 137.72
37311	3 1/8	1/13	1 521.23
37312	4 1/8	1/2	3 234.20
37317	6 1/8	1/1	13 703.40

COUDES OUVRÉS RÉDUITS 90° C x C (O.D.)			
# BMI	Taille O.D.	Emballage	\$
37319	5/8 x 1/2	25/500	211.47
37323	7/8 x 5/8	25/200	76.64
37328	1 1/8 x 5/8	10/80	226.94
37327	1 1/8 x 7/8	10/80	149.47
37332	1 3/8 x 7/8	20/120	413.93

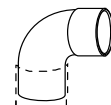

COUDES OUVRÉS 90° RACCORD x C (O.D.)			
# BMI	Taille O.D.	Emballage	\$
37342	3/8	25/800	82.89
37353	1/2	25/800	60.93
37354	5/8	25/500	27.80
37382	3/4	25/300	105.06
37355	7/8	25/200	51.35
37356	1 1/8	10/100	107.92
37357	1 3/8	1/50	260.67
37358	1 5/8	1/35	301.44
37359	2 1/8	1/17	510.61
37360	2 5/8	1/20	1 167.10
37361	3 1/8	1/6	1 678.62
37362	4 1/8	1/6	3 780.58

RACCORDS DE CUIVRE ACR - RÉFRIGÉRATION



COUDES LONG RAYON CxC 90° (O.D.)			
# BMI	Taille O.D.	Emballage	\$
37901	1/4	25/2000	132.70
37902	3/8	25/1200	65.98
37903	1/2	25/650	79.06
37904	5/8	25/350	70.91
37913	3/4	25/200	71.85
37905	7/8	10/120	89.16
37906	1 1/8	10/70	172.49
37907	1 3/8	1/35	299.23
37908	1 5/8	1/25	461.55
37909	2 1/8	1/12	788.57

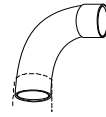

COUDES LONG RAYON RAC. x 90° (O.D.)			
# BMI	Taille O.D.	Emballage	\$
37951	1/4	25/2000	186.77
37952	3/8	25/1200	83.19
37953	1/2	25/750	154.76
37954	5/8	25/350	103.12
37963	3/4	25/200	121.93
37955	7/8	10/120	123.13
37956	1 1/8	10/60	199.96
37957	1 3/8	1/35	295.12
37958	1 5/8	1/25	555.61
37959	2 1/8	1/12	799.34

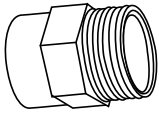

ADAPTATEURS OUVRÉS C x MIPS (O.D.)			
# BMI	Taille O.D.	Emballage	\$
37803	1/2 x 3/8	25/1000	156.22
37804	5/8 x 1/2	25/600	58.08
37805	7/8 x 3/4	25/250	83.65
37806	1 1/8 x 1	10/150	182.24
37807	1 3/8 x 1 1/4	1/80	251.79
37808	1 5/8 x 1 1/2	1/65	326.89
37809	2 1/8 x 2	1/38	471.91
37810	2 5/8 x 2 1/2	1/48	1 585.77
37811	3 1/8 x 3	1/36	1 883.04
37812	4 1/8 x 4	1/12	4 130.18

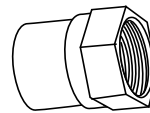

ADAPTATEURS OUVRÉS C x FIPS (O.D.)			
# BMI	Taille O.D.	Emballage	\$
37702	3/8 x 1/4	25/1500	134.01
37703	1/2 x 3/8	25/800	99.34
37704	5/8 x 1/2	25/450	68.83
37705	7/8 x 3/4	25/200	135.96
37706	1 1/8 x 1	10/140	214.53
37707	1 3/8 x 1 1/4	1/80	384.93
37708	1 5/8 x 1 1/2	1/60	422.28
37709	2 1/8 x 2	1/30	586.91
37710	2 5/8 x 2 1/2	1/24	1 962.83
37711	3 1/8 x 3	1/28	2 831.74

ADAPTATEURS OUVRÉS RÉDUITS C x MIPS (O.D.)			
# BMI	Taille O.D.	Emballage	\$
37817	1/2 x 1/2	25/500	142.49
37826	5/8 x 1/4	25/1000	114.05
37818	5/8 x 3/8	25/800	114.05
37822	5/8 x 3/4	25/250	126.17
37821	5/8 x 1	10/150	263.13
37823	7/8 x 1/2	25/250	162.54
37827	7/8 x 1	10/150	198.41
37832	1 1/8 x 1/2	10/180	320.60
37833	1 1/8 x 3/4	10/150	313.26
37831	1 1/8 x 1 1/4	1/85	488.37
37830	1 1/8 x 1 1/2	1/95	526.27
37837	1 3/8 x 3/4	1/120	365.03
37836	1 3/8 x 1	1/120	315.01
37835	1 3/8 x 1 1/2	1/90	546.74
37840	1 5/8 x 1	1/120	717.86
37839	1 5/8 x 1 1/4	1/60	437.38
37842	1 5/8 x 2	1/55	820.86

ADAPTATEURS OUVRÉS RÉDUITS C x FIPS (O.D.)			
# BMI	Taille O.D.	Emballage	\$
37719	5/8 x 1/4	25/800	96.66
37718	5/8 x 3/8	25/800	111.15
37717	5/8 x 3/4	25/300	146.13
37723	7/8 x 1/2	25/300	144.37
37722	7/8 x 1	10/140	233.09
37728	1 1/8 x 1/2	10/150	352.13
37727	1 1/8 x 3/4	10/150	240.89
37726	1 1/8 x 1 1/4	1/85	416.54
37734	1 3/8 x 3/4	1/120	468.71
37733	1 3/8 x 1	1/120	533.49
37732	1 3/8 x 1 1/2	1/100	560.63
37736	1 5/8 x 1 1/4	1/70	536.50
37742	1 5/8 x 2	1/60	892.62

** O.D. : Diamètre extérieur

RACCORDS DE CUIVRE ACR - RÉFRIGÉRATION

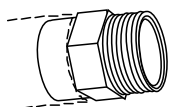

ADAPTEURS OUVRÉS RACCORD x MIPS (O.D.)			
# BMI	Taille O.D.	Emballage	\$
37884	5/8 x 1/2	25/500	129.59
37885	7/8 x 3/4	25/250	193.30
37886	1 1/8 x 1	10/130	223.57
37887	1 3/8 x 1 1/4	10/80	700.19
37888	1 5/8 x 1 1/2	1/80	795.00
37889	2 1/8 x 2	1/38	1 370.31

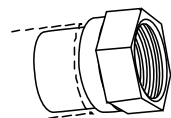

ADAPTEURS OUVRÉS RACCORD x FIPS (O.D.)			
# BMI	Taille O.D.	Emballage	\$
37784	5/8 x 1/2	25/500	132.94
37791	7/8 x 1/2	25/250	161.12
37785	7/8 x 3/4	25/250	153.81
37786	1 1/8 x 1	10/140	235.42
37787	1 3/8 x 1 1/4	1/85	402.01
37788	1 5/8 x 1 1/2	1/80	604.66
37789	2 1/8 x 2	1/40	770.02

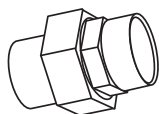

**Maintenant en
cuivre ouvert!**

UNIONS OUVRÉS C x C (O.D.)			
# BMI	Taille O.D.	Emballage	\$
37104	5/8	25/250	177.55
37105	7/8	25/100	354.12
37106	1 1/8	10/60	497.57
37107	1 3/8	5/45	737.79
37108	1 5/8	5/25	1 039.13
37109	2 1/8	1/24	1 679.54

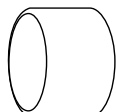

CAPUCHONS OUVRÉS EN CUIVRE (O.D.)			
# BMI	Taille O.D.	Emballage	\$
37502	3/8	25/2000	19.03
37503	1/2	25/1500	27.85
37504	5/8	25/1400	11.82
37513	3/4	25/850	34.88
37505	7/8	25/500	27.46
37506	1 1/8	10/300	64.01
37507	1 3/8	1/160	89.53
37508	1 5/8	1/140	130.08
37509	2 1/8	1/60	233.09
37510	2 5/8	1/50	650.19
37511	3 1/8	1/30	886.59
37512	4 1/8	1/25	1 660.06

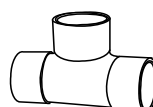

TÉS OUVRÉS CCC (O.D.)			
# BMI	Taille O.D.	Emballage	\$
37401	1/4	25/2000	137.13
37402	3/8	25/1300	137.13
37403	1/2	25/600	102.14
37404	5/8	25/300	37.08
37413	3/4	25/200	206.55
37405	7/8	10/120	80.94
37406	1 1/8	10/60	172.91
37407	1 3/8	1/35	247.78
37408	1 5/8	1/20	372.28
37409	2 1/8	1/10	658.02
37410	2 5/8	1/15	1 238.92
37411	3 1/8	1/10	2 220.02
37412	4 1/8	1/2	4 367.30
37414	6 1/8	1/1	19 536.26



TÉS OUVRÉS RÉDUITS CCC (O.D.)			
1/2", 5/8", 7/8"			
37417	1/2 x 1/2 x 3/8	25/600	236.97
37421	5/8 x 5/8 x 1/2	25/400	186.82
37420	5/8 x 5/8 x 7/8	10/180	130.57
37419	5/8 x 5/8 x 1 1/8	10/70	358.80
37431	7/8 x 5/8 x 5/8	10/180	104.26
37430	7/8 x 5/8 x 7/8	10/120	107.84
37429	7/8 x 7/8 x 5/8	10/170	109.93
37428	7/8 x 7/8 x 1 1/8	10/80	293.74
1 1/8"			
37450	1 1/8 x 5/8 x 5/8	10/100	247.92
37449	1 1/8 x 5/8 x 7/8	10/80	247.88
37448	1 1/8 x 5/8 x 1 1/8	10/60	235.42
37445	1 1/8 x 7/8 x 5/8	10/60	235.42
37443	1 1/8 x 7/8 x 7/8	10/60	235.42
37442	1 1/8 x 7/8 x 1 1/8	10/60	235.42
37439	1 1/8 x 1 1/8 x 5/8	10/100	172.57
37438	1 1/8 x 1 1/8 x 7/8	10/60	172.57
37437	1 1/8 x 1 1/8 x 1 3/8	1/35	436.49
37436	1 1/8 x 1 1/8 x 1 5/8	1/25	982.88
1 3/8"			
37465	1 3/8 x 5/8 x 1 3/8	1/35	423.19
37463	1 3/8 x 7/8 x 7/8	1/50	353.36
37462	1 3/8 x 7/8 x 1 1/8	1/45	375.91
37461	1 3/8 x 7/8 x 1 3/8	1/35	423.21
37460	1 3/8 x 1 1/8 x 5/8	1/60	353.36
37459	1 3/8 x 1 1/8 x 7/8	1/50	353.36
37458	1 3/8 x 1 1/8 x 1 1/8	1/50	353.36
37457	1 3/8 x 1 1/8 x 1 3/8	1/30	353.36
37455	1 3/8 x 1 3/8 x 5/8	1/50	249.92
37454	1 3/8 x 1 3/8 x 7/8	1/50	249.92
37453	1 3/8 x 1 3/8 x 1 1/8	1/40	249.92
37451	1 3/8 x 1 3/8 x 1 5/8	1/20	609.75

** O.D. : Diamètre extérieur

RACCORDS DE CUIVRE ACR - RÉFRIGÉRATION



TÉS OUVRÉS RÉDUITS CCC (O.D.)			
# BMI	Taille O.D.	Emballage	\$
1 5/8"			
37490	1 5/8 x 5/8 x 1 5/8	1/20	573.08
37489	1 5/8 x 7/8 x 5/8	1/40	650.16
37488	1 5/8 x 7/8 x 7/8	1/40	560.13
37487	1 5/8 x 7/8 x 1 1/8	1/40	560.13
37485	1 5/8 x 7/8 x 1 3/8	1/30	600.15
37486	1 5/8 x 7/8 x 1 5/8	1/20	560.13
37484	1 5/8 x 1 1/8 x 5/8	1/40	590.15
37483	1 5/8 x 1 1/8 x 7/8	1/30	560.13
37482	1 5/8 x 1 1/8 x 1 1/8	1/35	560.13
37481	1 5/8 x 1 1/8 x 1 3/8	1/20	575.15
37480	1 5/8 x 1 1/8 x 1 5/8	1/20	560.13
37479	1 5/8 x 1 3/8 x 5/8	1/40	560.13
37478	1 5/8 x 1 3/8 x 7/8	1/40	560.13
37477	1 5/8 x 1 3/8 x 1 1/8	1/30	560.13
37476	1 5/8 x 1 3/8 x 1 3/8	1/30	560.13
37475	1 5/8 x 1 3/8 x 1 5/8	1/20	560.13
37474	1 5/8 x 1 5/8 x 5/8	1/40	362.81
37473	1 5/8 x 1 5/8 x 7/8	1/35	345.32
37472	1 5/8 x 1 5/8 x 1 1/8	1/35	373.91
37471	1 5/8 x 1 5/8 x 1 3/8	1/25	392.32
37470	1 5/8 x 1 5/8 x 2 1/8	1/10	1 088.89
2 1/8"			
37532	2 1/8 x 5/8 x 2 1/8	1/15	1 089.57
37529	2 1/8 x 7/8 x 2 1/8	1/10	1 089.57
37527	2 1/8 x 1 1/8 x 1 1/8	1/20	1 225.83
37525	2 1/8 x 1 1/8 x 2 1/8	1/15	1 228.15
37524	2 1/8 x 1 3/8 x 1 1/8	1/20	870.49
37523	2 1/8 x 1 3/8 x 1 3/8	1/15	835.67
37522	2 1/8 x 1 3/8 x 2 1/8	1/10	982.91
37520	2 1/8 x 1 5/8 x 7/8	1/20	1 000.28
37519	2 1/8 x 1 5/8 x 1 1/8	1/20	796.42
37518	2 1/8 x 1 5/8 x 1 3/8	1/10	796.42
37517	2 1/8 x 1 5/8 x 1 5/8	1/10	796.42
37516	2 1/8 x 1 5/8 x 2 1/8	1/10	817.33
37498	2 1/8 x 2 1/8 x 5/8	1/20	606.17
37497	2 1/8 x 2 1/8 x 7/8	1/20	621.98
37496	2 1/8 x 2 1/8 x 1 1/8	1/18	665.77
37495	2 1/8 x 2 1/8 x 1 3/8	1/15	690.06
37491	2 1/8 x 2 1/8 x 1 5/8	1/10	717.37
2 5/8"			
37545	2 5/8 x 1 5/8 x 1 5/8	1/10	2 479.87
37544	2 5/8 x 1 5/8 x 2 5/8	1/20	2 064.03
37542	2 5/8 x 2 1/8 x 1 5/8	1/10	2 010.18
37541	2 5/8 x 2 1/8 x 2 1/8	1/8	2 010.18
37540	2 5/8 x 2 1/8 x 2 5/8	1/15	2 010.18
37539	2 5/8 x 2 5/8 x 5/8	1/25	1 387.04
37538	2 5/8 x 2 5/8 x 7/8	1/25	1 387.04
37537	2 5/8 x 2 5/8 x 1 1/8	1/25	1 387.04
37536	2 5/8 x 2 5/8 x 1 3/8	1/20	1 387.04
37535	2 5/8 x 2 5/8 x 1 5/8	1/20	1 387.04
37534	2 5/8 x 2 5/8 x 2 1/8	1/8	1 387.04

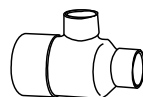

TÉS OUVRÉS RÉDUITS CCC (O.D.)			
# BMI	Taille O.D.	Emballage	\$
3 1/8"			
37560	3 1/8 x 2 1/8 x 2 1/8	1/15	2 479.87
37561	3 1/8 x 2 5/8 x 2 1/8	1/6	2 750.09
37562	3 1/8 x 2 5/8 x 2 5/8	1/15	2 750.09
37555	3 1/8 x 3 1/8 x 5/8	1/10	2 133.73
37554	3 1/8 x 3 1/8 x 7/8	1/20	2 133.73
37553	3 1/8 x 3 1/8 x 1 1/8	1/20	2 234.80
37552	3 1/8 x 3 1/8 x 1 3/8	1/15	2 234.80
37551	3 1/8 x 3 1/8 x 1 5/8	1/6	2 234.80
37550	3 1/8 x 3 1/8 x 2 1/8	1/13	2 234.80
37549	3 1/8 x 3 1/8 x 2 5/8	1/10	2 424.55
4 1/8", 6 1/8"			
37579	4 1/8 x 3 1/8 x 3 1/8	1/5	6 235.32
37576	4 1/8 x 4 1/8 x 7/8	1/8	4 601.93
37575	4 1/8 x 4 1/8 x 1 1/8	1/8	5 264.93
37574	4 1/8 x 4 1/8 x 1 3/8	1/8	4 367.94
37573	4 1/8 x 4 1/8 x 1 5/8	1/8	4 367.94
37572	4 1/8 x 4 1/8 x 2 1/8	1/6	4 367.94
37571	4 1/8 x 4 1/8 x 2 5/8	1/5	4 367.94
37570	4 1/8 x 4 1/8 x 3 1/8	1/2	4 670.55
37669	6 1/8 x 6 1/8 x 4 1/8	1/2	18 570.87

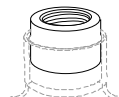

RACCORDS x FIPS DOUILLE À FLEUR OUVRÉS			
# BMI	Taille nominal	Emballage	\$
37169	1/2 x 1/4	25/1000	87.30
37170	1/2 x 1/8	25/1000	87.30

** O.D. : Diamètre extérieur

**LISTE DE PRIX BMI CANADA RACCORDS DE CUIVRE
ACR PLUS - RÉFRIGÉRATION**

**ACRP
26-1**

9 mars 2026



MANCHONS OUVRÉS C x C (O.D.)				
# BMI	# Modèle	Taille O.D.	Emballage	\$
43001	W01003	1/4	25/5000	11.96
43090	W01001	3/16	25/5000	21.01
43014	W01006	5/16	10/300	16.26
43002	W01009	3/8	25/2000	10.60
43003	W01017	1/2	25/1200	13.78
43004	W01022	5/8	25/800	23.92
43013	W01028	3/4	25/400	31.79
43005	W01034	7/8	25/250	68.49
43006	W01047	1 1/8	10/150	109.11
43007	W01055	1 3/8	1/100	119.23
43008	W01063	1 5/8	1/60	175.52
43009	W01072	2 1/8	1/40	346.18
43010	W01082	2 5/8	1/25	579.70
43011	W01092	3 1/8	1/30	852.70
43012	W010107	4 1/8	1/12	1 854.46

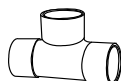

TÉS OUVRÉS CCC (O.D.)				
# BMI	# Modèle	Taille O.D.	Emballage	\$
43401	W40306	1/4	25/2000	68.80
43402	W04000	3/8	25/1300	55.32
43414	W40313	5/16	10/120	101.27
43403	W04001	1/2	25/600	51.39
43404	W04006	5/8	25/300	61.33
43413	W04017	3/4	25/200	128.93
43405	W04031	7/8	10/120	167.07
43406	W04048	1 1/8	10/60	269.27
43407	W04068	1 3/8	1/35	415.92
43408	W04084	1 5/8	1/20	578.71
43409	W40102	2 1/8	1/10	1 408.58
43410	W40123	2 5/8	1/15	1 878.19
43411	W40152	3 1/8	1/10	3 384.08

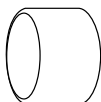

CAPUCHONS OUVRÉS EN CUIVRE (O.D.)				
# BMI	# Modèle	Taille O.D.	Emballage	\$
43504	W07007	5/8	25/1400	14.50
43513	W07008	3/4	25/850	23.14
43505	W07009	7/8	25/500	29.90
43506	W07011	1 1/8	10/300	64.72
43507	W07012	1 3/8	1/160	96.36
43508	W07013	1 5/8	1/140	124.53



MANCHONS OUVRÉS RÉDUITS C x C (O.D.)				
# BMI	# Modèle	Taille O.D.	Emballage	\$
43015	W01011	3/8 x 1/4	25/2000	34.03
43016	W01019	1/2 x 3/8	25/400	22.07
43020	W01025	5/8 x 3/8	25/800	26.21
43019	W01023	5/8 x 1/2	25/800	25.93
43022	W01030	3/4 x 1/2	25/600	39.92
43018	W01029	3/4 x 5/8	25/500	46.82
43025	W01038	7/8 x 3/8	25/400	54.95
43024	W01037	7/8 x 1/2	25/400	51.88
43023	W01036	7/8 x 5/8	25/350	60.44
43062	W01035	7/8 x 3/4	25/350	56.40
43063	W01050	1 1/8 x 3/4	10/200	93.76
43027	W01049	1 1/8 x 7/8	10/160	95.04
43032	W01058	1 3/8 x 7/8	1/100	144.90
43031	W01056	1 3/8 x 1 1/8	1/100	155.42
43038	W01069	1 5/8 x 5/8	1/100	234.58
43036	W01065	1 5/8 x 1 1/8	1/100	191.75
43035	W01064	1 5/8 x 1 3/8	1/100	209.79
43042	W01075	2 1/8 x 1 1/8	1/50	340.78
43041	W01074	2 1/8 x 1 3/8	1/50	323.18
43040	W01073	2 1/8 x 1 5/8	1/50	345.52
43047	W01084	2 5/8 x 1 5/8	1/30	754.56
43056	W010109	4 1/8 x 3 1/8	1/18	1 946.41



TÉS OUVRÉS RÉDUITS CCC (O.D.)				
# BMI	# Modèle	Taille O.D.	Emballage	\$
43416	W40324	3/8 x 3/8 x 1/4	25/350	165.34
43415	W04005	3/8 x 3/8 x 1/2	50/500	292.28
43418	W40350	1/2 x 1/2 x 1/4	25/600	72.02
43417	W04002	1/2 x 1/2 x 3/8	25/600	116.61
43419	W04004	1/2 x 3/8 x 3/8	25/600	131.19
43422	W04014	5/8 x 5/8 x 1/4	25/400	122.35
43423	W04008	5/8 x 5/8 x 3/8	25/400	129.34
43421	W04007	5/8 x 5/8 x 1/2	25/400	127.56
43425	W04010	5/8 x 1/2 x 1/2	25/400	130.57
43426	W04020	3/4 x 3/4 x 3/8	10/170	269.50
43427	W04018	3/4 x 3/4 x 5/8	10/170	269.50
43441	W04052	1 1/8 x 1 1/8 x 1/2	10/100	468.71
43438	W04049	1 1/8 x 1 1/8 x 7/8	10/60	265.51
43443	W04056	1 1/8 x 7/8 x 7/8	10/60	283.69
43455	W04071	1 3/8 x 1 3/8 x 5/8	1/50	414.69
43491	W40103	2 1/8 x 2 1/8 x 1 5/8	1/10	1 543.85



COUDES OUVRÉS 90° C x C (O.D.)				
# BMI	# Modèle	Taille O.D.	Emballage	\$
43301	W02003	1/4	25/3450	28.14
43302	W02009	3/8	25/1200	31.57
43303	W02017	1/2	25/1000	40.35
43304	W02022	5/8	25/500	71.85
43313	W02028	3/4	25/300	74.27
43305	W02034	7/8	25/200	93.45
43306	W02047	1 1/8	10/100	168.57
43308	W02085	1 5/8	1/35	383.56
43309	W02086	2 1/8	1/18	640.52
43311	W02088	3 1/8	1/13	1 636.35
43312	W02090	4 1/8	1/6	3 312.61

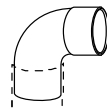

COUDES OUVRÉS 90° RACCORD x C (O.D.)				
# BMI	# Modèle	Taille O.D.	Emballage	\$
43342	W02312	3/8	25/800	36.74
43353	W02321	1/2	25/800	41.01
43354	W02326	5/8	25/500	43.67
43382	W02330	3/4	25/300	77.37
43355	W02334	7/8	25/200	91.70
43356	W02344	1 1/8	10/100	177.71
43357	W02384	1 3/8	1/50	300.56
43358	W02385	1 5/8	1/35	399.40
43359	W02386	2 1/8	1/17	667.01
43360	W02387	2 5/8	1/20	1 093.44

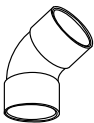

COUDES OUVRÉS 45° CxC (O.D.)				
# BMI	# Modèle	Taille O.D.	Emballage	\$
43201	W03005	1/4	25/2000	25.92
43202	W03012	3/8	25/1200	33.18
43203	W03021	1/2	25/800	30.08
43204	W03026	5/8	25/500	29.36
43213	W03030	3/4	25/300	73.65
43205	W03034	7/8	25/200	81.80
43206	W03044	1 1/8	10/100	149.09
43207	W03050	1 3/8	1/60	238.20
43208	W03055	1 5/8	1/40	305.10
43209	W03059	2 1/8	1/18	500.24
43210	W03063	2 5/8	1/20	999.64
43211	W03067	3 1/8	1/15	1 414.58

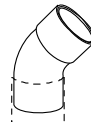

COUDES OUVRÉS 45° RACCORD x C (O.D.)				
# BMI	# Modèle	Taille O.D.	Emballage	\$
43252	W03312	3/8	25/1200	112.08
43253	W03321	1/2	25/800	69.92
43254	W03326	5/8	25/500	31.56
43282	W03330	3/4	25/300	75.66
43256	W03344	1 1/8	10/100	150.93
43257	W03350	1 3/8	1/60	225.39
43258	W03355	1 5/8	1/40	300.99
43259	W03359	2 1/8	1/18	488.52
43260	W03363	2 5/8	1/20	968.00

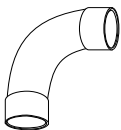

COUDES LONG RAYON CxC 90° (O.D.)				
# BMI	# Modèle	Taille O.D.	Emballage	\$
43901	W02715	1/4	25/2000	35.37
43915	W02710	5/16	10/120	81.85
43902	W02716	3/8	25/1200	41.88
43903	W02717	1/2	25/650	42.61
43904	W02722	5/8	25/350	64.57
43913	W02728	3/4	25/200	75.90
43905	W02734	7/8	10/120	145.77
43906	W02747	1 1/8	10/70	302.14
43907	W02055	1 3/8	1/35	326.30
43908	W02063	1 5/8	1/25	458.13
43909	W02072	2 1/8	1/12	916.25
43910	W02082	2 5/8	1/8	1 560.06
43911	W02092	3 1/8	1/6	2 705.11
43914	W02093	3 5/8	1/3	8 255.62
43912	W02095	4 1/8	1/3	7 643.07

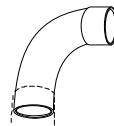

COUDES LONG RAYON RAC. x 90° (O.D.)				
# BMI	# Modèle	Taille O.D.	Emballage	\$
43951	W02805	1/4	25/2000	44.53
43952	W02809	3/8	25/1200	54.59
43953	W02817	1/2	25/750	66.27
43954	W02822	5/8	25/350	80.56
43963	W02828	3/4	25/200	91.53
43955	W02834	7/8	10/120	145.13
43956	W02847	1 1/8	10/60	212.45
43957	W02350	1 3/8	1/35	331.18
43958	W02355	1 5/8	1/25	462.53
43959	W02359	2 1/8	1/12	965.61
43961	W02368	3 1/8	1/3	2 686.10

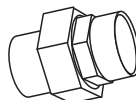

UNIONS OUVRÉS C x C (O.D.)				
# BMI	# Modèle	Taille O.D.	Emballage	\$
43103	W08002	1/2	25/250	289.06
43104	W08003	5/8	25/250	147.91
43105	W08004	7/8	25/100	325.06
43106	W08005	1 3/8	10/60	541.19

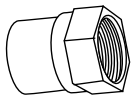

ADAPTATEURS OUVRÉS C x FIPS (O.D.)				
# BMI	# Modèle	Taille O.D.	Emballage	\$
43715	W01224	1/2 x 1/2	25/500	86.22
43718	W01232	5/8 x 3/8	25/800	72.16
43704	W01231	5/8 x 1/2	25/450	103.40
43717	W01230	5/8 x 3/4	25/300	112.15
43721	W01238	3/4 x 3/4	20/200	143.00
43705	W01246	7/8 x 3/4	25/200	135.63
43722	W01245	7/8 x 1	10/140	236.44
43706	W01263	1 1/8 x 1	10/140	218.47
43708	W01279	1 5/8 x 1 1/2	1/60	454.28
43709	W01287	2 1/8 x 2	1/36	710.37

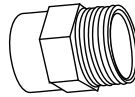

ADAPTATEURS OUVRÉS C x MIPS (O.D.)				
# BMI	# Modèle	Taille O.D.	Emballage	\$
43803	W01125	1/2 x 3/8	25/1000	62.35
43817	W01124	1/2 x 1/2	25/500	83.86
43818	W01132	5/8 x 3/8	25/800	80.33
43804	W01131	5/8 x 1/2	25/600	74.05
43822	W01130	5/8 x 3/4	25/250	131.39
43821	W01138	3/4 x 3/4	10/150	142.15
43805	W01146	7/8 x 3/4	25/250	125.89
43827	W01145	7/8 x 1	10/150	225.85
43833	W01164	1 1/8 x 3/4	10/150	206.20
43806	W01163	1 1/8 x 1	10/150	219.32
43807	W01171	1 3/8 x 1 1/4	1/100	333.01
43808	W01179	1 5/8 x 1 1/2	1/65	462.96

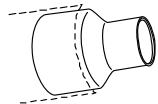

RÉDUCTEURS OUVRÉS RAC. x C (O.D.)				
# BMI	# Modèle	Taille O.D.	Emballage	\$
43115	W01306	3/8 x 1/4	25/1200	22.67
43117	W01314	1/2 x 1/4	25/1000	28.14
43116	W01312	1/2 x 3/8	25/1200	26.91
43120	W01317	5/8 x 3/8	25/1000	24.23
43119	W01315	5/8 x 1/2	25/1000	24.96
43121	W01321	3/4 x 1/2	25/400	90.34
43118	W01320	3/4 x 5/8	25/1000	34.03
43125	W01328	7/8 x 3/8	25/400	55.84
43124	W01327	7/8 x 1/2	25/400	52.92
43123	W01326	7/8 x 5/8	25/400	51.96
43162	W01325	7/8 x 3/4	25/400	50.49
43129	W01340	1 1/8 x 1/2	10/200	92.64
43128	W01339	1 1/8 x 5/8	10/200	91.02
43163	W01338	1 1/8 x 3/4	10/170	84.72
43127	W01337	1 1/8 x 7/8	10/160	86.83
43131	W01343	1 3/8 x 1 1/8	1/100	132.57
43138	W01355	1 5/8 x 5/8	1/100	307.51
43137	W01353	1 5/8 x 7/8	1/100	198.05
43136	W01351	1 5/8 x 1 1/8	1/100	189.92
43135	W01350	1 5/8 x 1 3/8	1/100	188.45
43143	W01362	2 1/8 x 7/8	1/50	396.07
43142	W01360	2 1/8 x 1 1/8	1/50	363.50
43141	W01359	2 1/8 x 1 3/8	1/50	333.79
43140	W01358	2 1/8 x 1 5/8	1/50	383.13
43149	W01370	2 5/8 x 1 1/8	1/30	772.88
43147	W01368	2 5/8 x 1 5/8	1/30	495.11
43152	W01377	3 1/8 x 2 1/8	4/20	793.05
43151	W01376	3 1/8 x 2 5/8	1/15	786.31
43156	W01387	4 1/8 x 3 1/8	1/18	1 800.21



RETOURS-U OUVRÉS CxC (O.D.)				
# BMI	# Modèle	Taille O.D.	Emballage	\$
43922	W06056	5/8 x 2 1/4	10/100	293.05
43927	W06092	7/8 x 2 1/2	5/60	178.02
43930	W60110	1 1/8 x 3	1/40	365.70
43931	W60121	1 3/8 x 4	1/30	669.24
43932	W60131	1 5/8 x 4 3/8	1/20	875.98
43933	W60140	2 1/8 x 5 1/2	1/10	3 779.07



SIPHONS-P OUVRÉS C x C (O.D.)				
# BMI	# Modèle	Taille O.D.	Emballage	\$
43604	W60999	5/8	10/200	337.15
43613	W61008	3/4	10/200	490.97
43605	W61000	7/8	1/10	545.72
43606	W61001	1 1/8	5/35	918.00
43607	W61002	1 3/8	1/5	1 264.53
43608	W61003	1 5/8	1/12	2 113.36
43609	W61009	2 1/8	1/6	3 834.11

LISTE DE PRIX BMI CANADA UNIONS DIÉLECTRIQUES SANS PLOMB



**DIE
25-1**

12 mars 2025

UNIONS DIÉLECTRIQUES SANS PLOMB

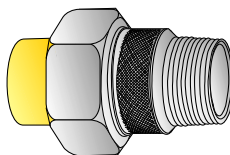
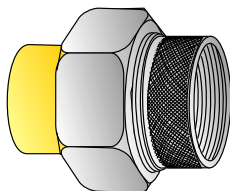

REG: 80°C (156°F) - 250 psi (17.24 BAR)

MAX: 150°C (302°F) - 50 psi (3.45 BAR)

TOUTES LES UNIONS DIÉLECTRIQUES DE BMI ONT UN NOUVEL ISOLANT À HAUTE TEMPÉRATURE (ROUGE)

UNIONS DIÉLECTRIQUES C x F				
#BMI	Taille	Emballage	Code à barres	\$
07404	1/2	10/100	777701074042	22.50
07405	3/4	10/80	777701074059	26.90
07406	1	10/50	777701074066	40.10
07407	1 1/4	5/40	777701074073	53.14
07408	1 1/2	4/24	777701074080	79.23
07409	2	2/18	777701074097	133.16
07423	1/2 x 3/4	10/80	777701074233	26.59

UNIONS DIÉLECTRIQUES C x M				
#BMI	Taille	Emballage	Code à barres	\$
07434	1/2	12/144	777701074349	28.68
07435	3/4	10/80	777701074356	32.99

UNIONS À BRIDE DIÉLECTRIQUE SANS PLOMB

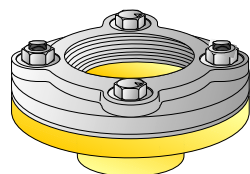

FONTE GRISE GALV. FIPS
X
BRONZE À SOUDER

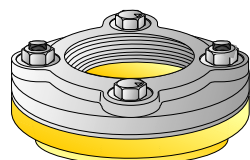

FONTE GRISE GALV. FIPS
X
BRONZE FIPS

UNIONS À BRIDES DIÉLECTRIQUE C x F				
#BMI	Taille	Emballage	Code à barres	\$
07570	2 1/2	1/1	777701075704	1 045.76
07571	3	1/1	777701075711	1 152.11
07572	4	1/1	777701075728	1 595.19

UNIONS À BRIDES DIÉLECTRIQUE F x F				
#BMI	Taille	Emballage	Code à barres	\$
07590	2 1/2	1/1	777701075902	1 506.62
07591	3	1/1	777701075919	1 772.45
07592	4	1/1	777701075926	2 658.69

UNIONS À BRIDES DIÉLECTRIQUES RÉGULIERS

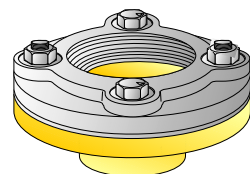

FONTE GRISE GALV. FIPS
X
BRONZE À SOUDER

UNIONS À BRIDES DIÉLECTRIQUE C x F				
#BMI	Taille	Emballage	Code à barres	\$
07550	2 1/2	1/5	777701075506	871.49
07551	3	1/5	777701075513	960.11
07552	4	1/2	777701075520	1 329.36

PIÈCES POUR UNIONS DIÉLECTRIQUES

Viton®

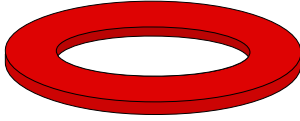

**JOINT PLAT
EN CAOUTCHOUC VITON_R
POUR HAUTE TEMPERATURE**

Nylon

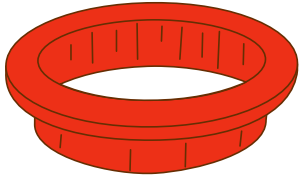

**MANCHON ISOLATEUR
HAUTE RESISTANCE
EN NYLON**

#BMI	Taille	Emballage	Code à barres	\$
07604	1/2	1/1	777701076046	3.23
07605	3/4	1/1	777701076053	3.92
07606	1	1/1	777701076060	5.13
07607	1 1/4	1/1	777701076077	7.71
07608	1 1/2	1/1	777701076084	10.27
07609	2	1/1	777701076091	12.20

#BMI	Taille	Emballage	Code à barres	\$
07804	1/2	1/1	777701078040	0.83
07805	3/4	1/1	777701078057	1.10
07806	1	1/1	777701078064	1.38
07807	1 1/4	1/1	777701078071	1.71
07808	1 1/2	1/1	777701078088	2.13
07809	2	1/1	777701078095	2.61



LISTE DE PRIX BMI CANADA RUBAN-T
ET PLOMBERIE GÉNÉRALE

TEF
26-1

9 mars 2026

RUBAN-T BLANC



#BMI	Taille	Emballages	Code à barres	\$
28000	1/2 x 480 x .003 x .5g / cm ³	100/1000	777701280009	1.67

EMBALLAGE TUBULAIRE DE 10 PIÈCES

RUBAN-T ROSE POUR LE GAZ OU L'HUILE



#BMI	Taille	Emballages	Code à barres	\$
28001	1/2 x 540 x .004 x 1.3g / cm ³	50/500	777701280016	14.63
28002	3/4 x 540 x .004 x 1.3g / cm ³	50/500	777701280023	21.69
28003	1/2 x 1296 x .004 x 1.3g / cm ³	50/300	777701280030	30.68

EMBALLAGE TUBULAIRE DE 10 PIÈCES

*** CONVIENT POUR LA DISTRIBUTION DE L'ESSENCE, DES HUILES DE PÉTROLE, PROPANE, BUTANE, NAPHTA, LE BENZÈNE, LE KÉROSÈNE ET LE GAZ NATUREL.

RUBAN-T JAUNE POUR LE GAZ OU L'HUILE



#BMI	Taille	Emballages	Code à barres	\$
28009	1/2 x 540 x .004 x 1.3g / cm ³	50/500	777701280092	14.63
28010	3/4 x 540 x .004 x 1.3g / cm ³	50/500	777701280108	21.69

EMBALLAGE TUBULAIRE DE 10 PIÈCES

*** CONVIENT POUR LA DISTRIBUTION DE L'ESSENCE, DES HUILES DE PÉTROLE, PROPANE, BUTANE, NAPHTA, LE BENZÈNE, LE KÉROSÈNE ET LE GAZ NATUREL.

ATTACHE CÂBLE

JUSQU'À L'ÉPUISEMENT DES STOCKS - VENTE FINALE



#BMI	Taille	Emballages	Code à barres	\$
ATTACHE CÂBLE NOIR				
28604	6" NOIR (SAC DE 100)	10/250	777701286049	4.93

Quantité minimale de commande « Inner »

ATTACHE EN "J" CLOU INCLUS

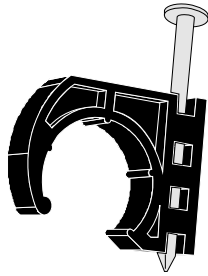

BMI#	Taille	Qté Inner	Qté Master	Codes à barres	\$
28304	1/2	100	1000	777701283048	0.22
28305	3/4	100	500	777701283055	0.35
28306	1	50	250	777701283062	0.49

ATTACHE EN "D" CLOU INCLUS

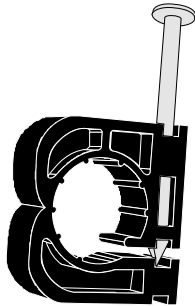

BMI#	Taille	Qté Inner	Qté Master	Codes à barres	\$
28314	1/2	100	4000	777701283147	0.29
28315	3/4	50	2000	777701283154	0.35

ATTACHE EN "O" AVEC OREILLES

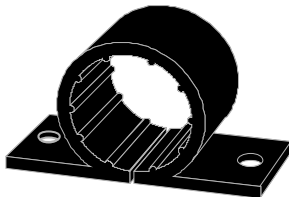

BMI#	Taille	Qté Inner	Qté Master	Codes à barres	\$
28324	1/2	50	2400	777701283246	0.50
28325	3/4	50	1800	777701283253	0.54
28326	1	50	1000	777701283260	0.86

ATTACHE EN "A" AVEC OREILLES

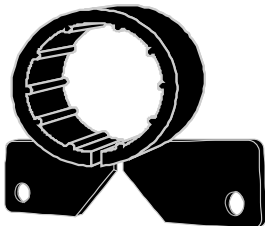

BMI#	Taille	Qté Inner	Qté Master	Codes à barres	\$
28334	1/2	50	2400	777701283345	0.50
28335	3/4	50	1800	777701283352	0.54
28336	1	50	1000	777701283369	0.86

SUPPORT DE COURBE 90° AVEC BRIDE



BMI#	Taille	Qté Inner	Qté Master	Codes à barres	\$
28154	1/2	20	500	777701281549	4.30

BRIDES DE TOILETTE EN LAITON CONN. JOINT DE PLOMB

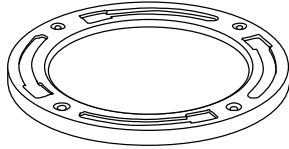

#BMI	Taille	Emballages	Codes à barres	\$
28501	LÉGÈRES	1/50	777701285011	54.21
28504	EXTRA-LOURDES *	1/25	777701285042	78.36

* La bride extra-lourde a été spécialement conçue pour les planchers inégaux tel que le béton, céramique, etc.

ASSEMBLAGE DE BOULONS EN LAITON

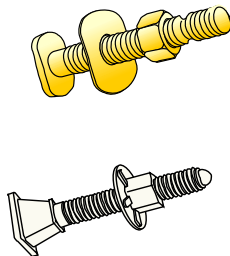

#BMI	Taille	Emballages	Codes à barres	\$
28500	5/16" x 2 1/4" (60MM)	100/400	777701285004	9.66
28502	5/16" x 2 1/4" (60MM) - Set of 2	50/200	777701285028	21.76
ASSEMBLAGE DE BOULONS EN NYLON				
28506	5/16" x 2 1/2" (63.5MM) - Set of 2	50/500	777701285066	7.82

ADAPTATEURS POUR RENVOI CONN. MULTIPLES



Type "A"

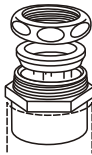

Type "B"

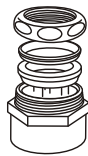

Type "C"

#BMI	Taille	Emballages	Type	\$
28638	1 1/2" M ou Cuivre x 1 1/2" ou 1 1/4" Coul.	10/100	A	45.70
28646	1 1/2" RACC. x 1 1/4" Coulissant	10/80	B	73.13
28648	1 1/2" F x 1 1/2" ou 1 1/4" Coulissant	10/50	C	69.55



LISTE DE PRIX BMI CANADA PLOMBERIE GÉNÉRALE

GSP
25-1

12 mars 2025

2" DRAINS DE DOUCHE ABS DEUX PIÈCES

#BMI	Description	Emballage	Code à barres	\$
08123	DRAINS A/GRILLE PLAST. BLANC	25/50	777701081231	16.92
08124	DRAINS A/GRILLE ACIER INOX.	25/50	777701081248	20.20
08120	GRILLES PLAST. BLANC	1/1	777701081200	3.42
08122	GRILLES ACIER INOX.	1/1	777701081224	8.40



#08123 Grille blanche #08124 Acier Inoxydable

2" DRAINS DE DOUCHE SANS COLLE

#BMI	Description	Emballage	Code à barres	\$
08012	GRILLES ACIER INOX.	1/50	777701080128	22.84

AVEC JOINT DE CAOUTCHOUC
AUCUN SOLVANT, OU JOINT MÉCANIQUE
S'AJUSTE AUX TUYAUX ABS, PVC, FONTE OU ACIER

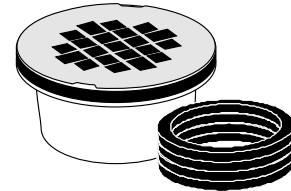

CONTRÔLES DE CRUE EN LAITON SOLIDE

#BMI	Description	Emballage	Code à barres	\$
08107	2" ANTI-REFOULEMENT	1/100	777701081071	23.28
08108	3" ANTI-REFOULEMENT	1/30	777701081088	42.76
08109	4" ANTI-REFOULEMENT	1/15	777701081095	69.69

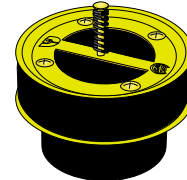

GRILLES DE PLANCHER EN ACIER INOXYDABLE

#BMI	Description	Emballage	Code à barres	\$
08031	Pour tuyau 2" (3" diam. extér.)	5/180	777701080319	12.23
08032	Pour tuyau 3" (4" diam. extér.)	5/150	777701080326	11.32
08033	Pour tuyau 4" (5" diam. extér.)	5/80	777701080333	18.15

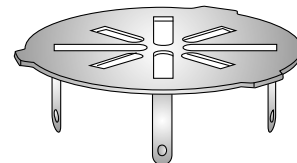

TUBES DE PLASTIQUE POUR RENVOI DE CHAUFFE-EAU

#BMI	Description	Emballage	Code à barres	\$
08604	1/2 x 3/4 M x F COUDES 90°	25/100	777701086045	7.28
08605	3/4 M x F COUDES 90°	25/100	777701086052	8.61
08614	3/4 x 42 TUBES (40 GALLONS)	50/100	777701086144	10.52
08616	3/4 x 54 TUBES (60 GALLONS)	50/100	777701086168	12.59
08618	ENSEMBLE POUR VENTE AU DÉTAIL	25/50	777701086182	26.21
	(08605 / 08616) -> 08618			

TESTÉ PAR WARNOCK HERSEY

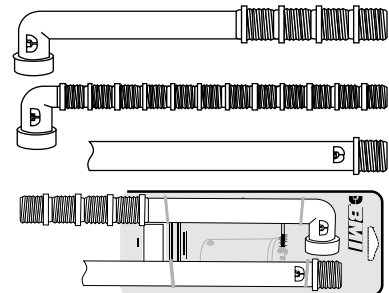

LISTE DE PRIX BMI CANADA - VALVES À BILLE & ADAPTATEURS CHROMÉS



**CPV
26-1**

9 mars 2026

VALVES À BILLE CHROMÉES QUART DE TOUR



TOUS LES ARTICLES SUR CETTE PAGE - EMBALLAGE 10/100

** O.D. : Diamètre extérieur

DROITE

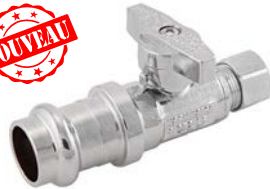

PRESS x COMPRESSION			
#BMI	Taille	Code à barres	\$
09654	1/2 PRESS x 3/8 OD	777701096549	66.74

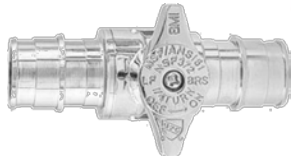

EXP x EXP (F1960)			
#BMI	Taille	Code à barres	\$
09104	1/2 EXP. x 1/2 EXP.	777701091049	55.59
09105	3/4 EXP. x 3/4 EXP.	777701091056	69.76



EXP x COMPRESSION			
#BMI	Taille	Code à barres	\$
09625	1/2 EXP x 1/4 OD	777701096259	53.64
09624	1/2 EXP x 3/8 OD	777701096242	53.39



PEX x PEX			
#BMI	Taille	Code à barres	\$
09604	1/2 PEX x 1/2 PEX	777701096044	23.65



PEX x COMPRESSION			
#BMI	Taille	Code à barres	\$
09637	1/2 PEX x 1/4 OD	777701096372	31.72
09634	1/2 PEX x 3/8 OD	777701096341	28.37



COP x COMPRESSION			
#BMI	Taille	Code à barres	\$
09614	1/2 C x 3/8 OD	777701096143	28.21



F x COMPRESSION			
#BMI	Taille	Code à barres	\$
09610	3/8 F x 3/8 OD	777701096105	29.21
09612	1/2 F x 3/8 OD	777701096129	30.69



REV x COMPRESSION			
#BMI	Taille	Code à barres	\$
09620	3/8 REV x 3/8 OD	777701096204	36.48



COMPRESSION x COMPRESSION			
#BMI	Taille	Code à barres	\$
09684	5/8 OD x 3/8 OD	777701096846	33.57



VALVES À BILLE CHROMÉES QUART DE TOUR

TOUS LES ARTICLES SUR CETTE PAGE - EMBALLAGE 10/100



** O.D. : Diamètre extérieur

À ANGLE



PRESS x COMPRESSION			
#BMI	Taille	Code à barres	\$
09659	1/2 PRESS x 3/8 OD	777701096594	66.74



EXP x COMPRESSION			
#BMI	Taille	Code à barres	\$
09630	1/2 EXP x 1/4 OD	777701096303	53.64
09629	1/2 EXP x 3/8 OD	777701096297	53.39



PEX x COMPRESSION			
#BMI	Taille	Code à barres	\$
09636	1/2 PEX x 1/4 OD	777701096365	31.72
09639	1/2 PEX x 3/8 OD	777701096396	28.37



COP x COMPRESSION			
#BMI	Taille	Code à barres	\$
09619	1/2 C x 3/8 OD	777701096198	28.58



F x COMPRESSION			
#BMI	Taille	Code à barres	\$
09615	3/8 F x 3/8 OD	777701096150	28.84
09617	1/2 F x 3/8 OD	777701096174	30.24



COMPRESSION x COMPRESSION			
#BMI	Taille	Code à barres	\$
09689	5/8 OD x 3/8 OD	777701096891	33.78

VALVES À BILLE CHROMÉES 1/4 DE TOUR À DOUBLE SORTIE



PEX x COMPRESSION			
#BMI	Taille	Code à barres	\$
09638	1/2 PEX x 3/8 OD x 3/8 OD	777701096389	45.58



COMPRESSION x COMPRESSION			
#BMI	Taille	Code à barres	\$
09687	5/8 OD x 3/8 OD x 1/4 OD	777701096877	45.58
09688	5/8 OD x 3/8 OD x 3/8 OD	777701096884	45.58



BRIDES CHROMÉES



#BMI	Taille	Emballage	Code à barres	\$
09400	1/2 Cuivre	500/2000	777701094002	1.61 \$
09401	3/8 IPS	500/2000	777701094019	1.42 \$
09402	1/2 IPS	500/2000	777701094026	1.47 \$

VALVES À BILLE CHROMÉES

PUSH-FIT



VOIR LA LISTE
DE PRIX PFTLS

ANTIBÉLIERS



VOIR LA LISTE
DE PRIX WHALS

**LISTE DE PRIX BMI CANADA DISPOSITIFS
ANTIBÉLIERIS SANS PLOMB**



**WHA
26-1**

9 mars 2026

TYPE COMMERCIAL

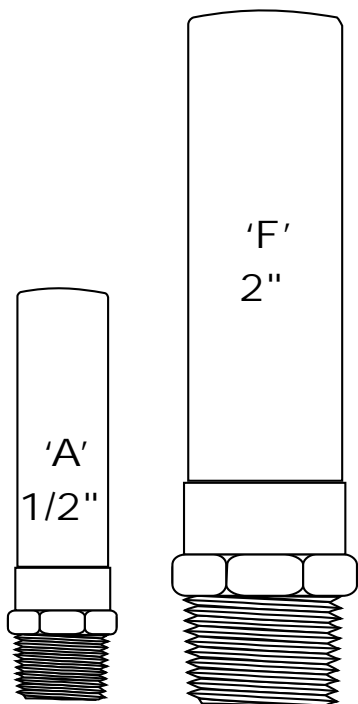

MIPS INLETS					
#BMI	Taille	Emballage	Type	Codes à barres	\$
31104	1/2	1/50	'A'	777701311048	98.16
31105	3/4	1/30	'B'	777701311055	157.76
31106	1	1/24	'C'	777701311062	243.40
31107	1 1/4	1/12	'D'	777701311079	595.85
31108	1 1/2	1/8	'E'	777701311086	948.35
31109	2	1/6	'F'	777701311093	1 057.30



DISPOSITIFS ANTIBÉLIERS TYPE AA SANS PLOMB

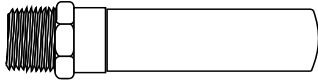

MIPS				
#BMI	Taille	Emballage	Codes à barres	\$
31204	1/2	25/50	777701312045	44.70
31205	3/4	25/50	777701312052	47.57

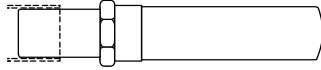

RACC. CUIVRE				
#BMI	Taille	Emballage	Codes à barres	\$
31214	1/2	25/50	777701312144	47.42
31215	3/4	1/160	777701312151	50.52

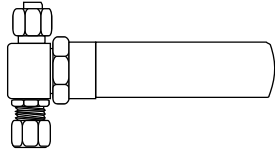

NOIX INVERSÉ x COMPRESSION				
#BMI	Taille	Emballage	Codes à barres	\$
31263	3/8 O.D.	25/50	777701312632	78.72
31264	5/8 O.D.	1/80	777701312649	79.27

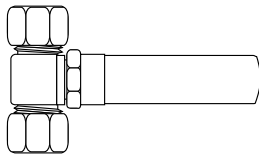

TÉS COMPRESSION				
#BMI	Taille	Emballage	Codes à barres	\$
31243	3/8 O.D.	1/80	777701312434	66.06



COMPRESSION				
#BMI	Taille	Emballage	Codes à barres	\$
31234	5/8" O.D.	1/160	777701312342	54.33

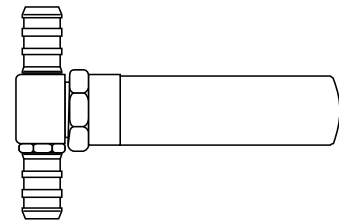

PEX x PEX				
#BMI	Taille	Emballage	Codes à barres	\$
31274	1/2	25/50	777701312748	59.29

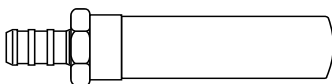

PEX				
#BMI	Taille	Emballage	Codes à barres	\$
31224	1/2	25/50	777701312243	41.36

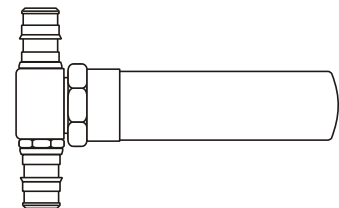

EXP x EXP (F1960)				
#BMI	Taille	Emballage	Codes à barres	\$
31474	1/2	25/50	777701314742	68.32



EXP (F1960)				
#BMI	Taille	Emballage	Codes à barres	\$
31424	1/2	25/50	777701314247	49.11

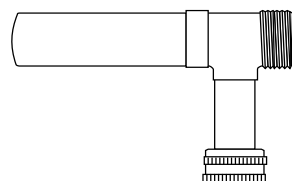

"HOSE" MALE x FEMELLE POUR LAVE-LINGE (LAITON RÉGULIER)				
#BMI	Taille	Emballage	Codes à barres	\$
31985	3/4	5/50	777701319853	62.96



DISPOSITIFS ANTIBÉLIERS COMPACTS

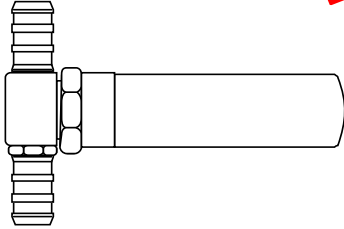

PEX x PEX				
#BMI	Taille	Emballage	Codes à barres	\$
31634	1/2	25/50	777701316340	50.40



PEX				
#BMI	Taille	Emballage	Codes à barres	\$
31624	1/2	50/100	777701316241	35.15

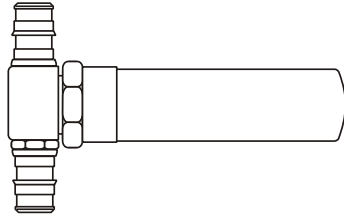

EXP x EXP (F1960)				
#BMI	Taille	Emballage	Codes à barres	\$
31784	1/2	25/50	777701317842	58.07

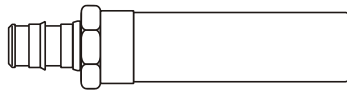

EXP (F1960)				
#BMI	Taille	Emballage	Codes à barres	\$
31734	1/2	50/100	777701317347	41.75

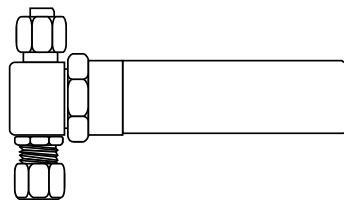

NOIX INVERSÉ x COMPRESSION				
#BMI	Taille	Emballage	Codes à barres	\$
31747	3/8 O.D.	25/50	777701317477	66.93



VALVES PLAQUÉES CHROME AVEC DISPOSITIFS ANTIBÉLIERS

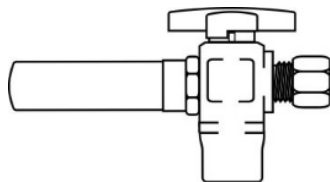

RACC. CUIVRE				
#BMI	Taille	Emballage	Codes à barres	\$
31314	1/2 COP x 3/8 OD DROIT	5/50	777701313141	73.45
31319	1/2 COP x 3/8 OD ANGLE	5/50	777701313196	73.45

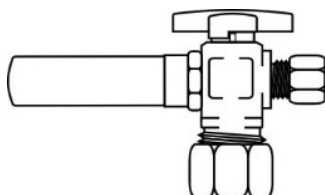

COMPRESSION				
#BMI	Taille	Emballage	Codes à barres	\$
31384	5/8 OD x 3/8 OD DROIT	5/50	777701313844	83.16
31389	5/8 OD x 3/8 OD ANGLE	5/50	777701313899	83.16

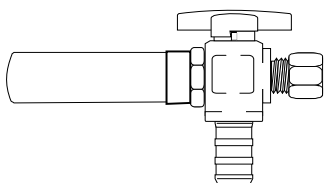

PEX				
#BMI	Taille	Emballage	Codes à barres	\$
31248	1/2 PEX x 3/8 OD DROIT	5/50	777701312489	73.98
31249	1/2 PEX x 3/8 OD ANGLE	5/50	777701312496	73.98

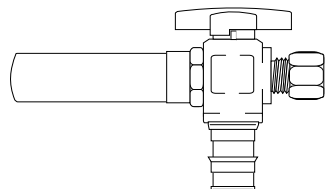

EXPANSION À FROID (F1960)				
#BMI	Taille	Emballage	Codes à barres	\$
31258	1/2 EXP x 3/8 OD DROIT	5/50	777701312588	82.30
31259	1/2 EXP x 3/8 OD ANGLE	5/50	777701312595	82.30

VALVES PLAQUÉES CHROME AVEC DISPOSITIFS ANTIBÉLIERS COMPACTS

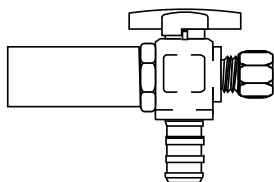

PEX				
#BMI	Taille	Emballage	Codes à barres	\$
31548	1/2 PEX x 3/8 OD DROIT	5/50	777701315480	66.60
31549	1/2 PEX x 3/8 OD ANGLE	5/50	777701315497	66.60

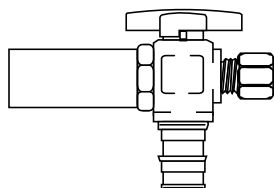

EXPANSION À FROID (F1960)				
#BMI	Taille	Emballage	Codes à barres	\$
31558	1/2 EXP x 3/8 OD DROIT	5/50	777701315589	74.93
31559	1/2 EXP x 3/8 OD ANGLE	5/50	777701315596	74.93





LISTE DE PRIX BMI CANADA - MANCHONS J.M.

NHC

25-1

12 mars 2025

MANCHONS J.M. RÉGULIER

#BMI	Taille	Emballage	Palette	\$
18908	1 1/2	100	7 200	11.25
18909	2	100	6 300	12.23
18911	3	100	3 200	14.26
18912	4	60	2 520	16.55
18913	5	30	1 440	34.86
18914	6	20	720	37.76
18918	8	15	360	53.14
18919	10	12	288	70.31
18920	12	8	104	118.25
18921	15	4	112	203.29

18940	2 x 1 1/2	100	6 300	14.91
18952	3 x 2	100	3 200	22.18
18958	4 x 2	64	2 048	35.55
18956	4 x 3	64	2 048	33.58

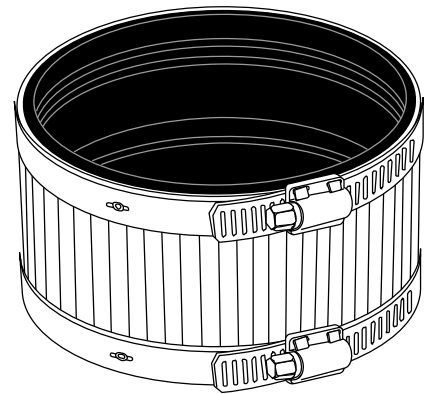

CAN/ULC-S102

LISTE DE PRIX BMI CANADA
RACCORDS EN ACIER AU CARBONE "PRESS" EPDM

CPS
25-1

12 mars 2025

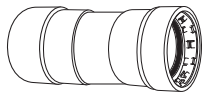

MANCHONS PRF x PRF					
#BMI	#Apollo	#Viega	Taille	Emballage	\$
45004	PWR7480000	25000	1/2	10/100	20.41
45005	PWR7480011	22005	3/4	10/100	23.36
45006	PWR7480022	25010	1	5/50	34.86
45007	PWR7480033	25015	1 1/4	1/30	44.37
45008	PWR7480044	25020	1 1/2	1/25	59.91
45009	PWR7480055	25025	2	1/20	86.76

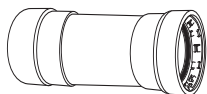

MANCHONS PRF x PRF SANS ARRÊT					
#BMI	#Apollo	#Viega	Taille	Emballage	\$
45074	PWR7480066	25030	1/2	10/100	24.72
45075	PWR7480077	25035	3/4	10/100	27.64
45076	PWR7480088	25040	1	5/50	39.16
45077	PWR7480099	25045	1 1/4	1/25	49.44
45078	PWR7480101	25050	1 1/2	1/25	65.22
45079	PWR7480110	25055	2	1/15	92.19

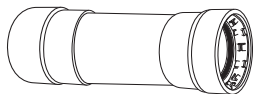

MANCHONS COULISSANTS PRF x PRF SANS ARRÊT					
#BMI	#Apollo	#Viega	Taille	Emballage	\$
45084	N/A	25070	1/2	10/50	70.56
45085	N/A	25075	3/4	10/50	75.87
45086	N/A	25080	1	5/25	88.88
45087	N/A	25085	1 1/4	1/20	96.12
45088	N/A	25090	1 1/2	1/10	98.66
45089	N/A	25095	2	1/10	101.91

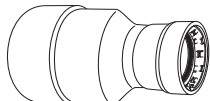

MANCHONS RÉDUITS PRF x PRF					
#BMI	#Apollo	#Viega	Taille	Emballage	\$
45023	PWR7483025	25930	3/4 x 1/2	5/50	26.24
45028	PWR7483036	25935	1 x 1/2	5/35	31.10
45027	PWR7483047	25940	1 x 3/4	5/40	31.58
45031	PWR7483069	25950	1 1/4 x 1	1/20	48.34
45037	N/A	N/A	1 1/2 x 3/4	1/1	67.32
45036	N/A	N/A	1 1/2 x 1	1/1	63.36
45035	PWR7483071	25955	1 1/2 x 1 1/4	1/15	60.77
45041	PWR7483080	25960	2 x 1 1/4	1/15	80.86
45040	PWR7483091	25965	2 x 1 1/2	1/15	89.83



CAPUCHONS					
#BMI	#Apollo	#Viega	Taille	Emballage	\$
45504	PWR7481232	25730	1/2	10/120	25.52
45505	PWR7481243	25735	3/4	10/100	26.72
45506	PWR7481254	25740	1	5/75	30.28
45507	PWR7481265	25745	1 1/4	1/50	51.57
45508	PWR7481276	25750	1 1/2	1/25	65.69
45509	PWR7481287	25755	2	1/20	81.01

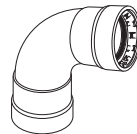

COUDES 90° PRF x PRF					
#BMI	#Apollo	#Viega	Taille	Emballage	\$
45304	PWR7480121	25200	1/2	10/80	22.65
45305	PWR7480132	25205	3/4	10/60	25.33
45306	PWR7480143	25210	1	5/30	30.82
45307	PWR7480154	25215	1 1/4	1/15	52.57
45308	PWR7480165	25220	1 1/2	1/10	67.85
45309	PWR7480176	25225	2	1/10	100.60

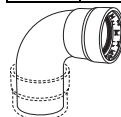

COUDES 90° RACCORD x PRF					
#BMI	#Apollo	#Viega	Taille	Emballage	\$
45354	PWR7480187	26050	1/2	10/80	22.65
45355	PWR7480198	26055	3/4	10/60	24.84
45356	PWR7480209	26060	1	5/40	30.24
45357	PWR7480211	26065	1 1/4	1/20	52.57
45358	PWR7480220	26070	1 1/2	1/15	67.85
45359	PWR7480231	26075	2	1/10	100.60



COUDES 45° PRF x PRF					
#BMI	#Apollo	#Viega	Taille	Emballage	\$
45204	PWR7480242	25230	1/2	10/100	22.97
45205	PWR7480253	25235	3/4	10/80	27.87
45206	PWR7480264	25240	1	5/50	35.07
45207	PWR7480275	25245	1 1/4	1/25	62.78
45208	PWR7480286	25250	1 1/2	1/20	78.75
45209	PWR7480297	25255	2	1/10	109.06



COUDES 45° RACCORD x PRF					
#BMI	#Apollo	#Viega	Taille	Emballage	\$
45254	PWR7480308	26100	1/2	10/100	23.66
45255	PWR7480319	26105	3/4	10/70	28.72
45256	PWR7480321	26110	1	5/50	36.13
45257	PWR7480330	26115	1 1/4	1/30	62.78
45258	PWR7480341	26120	1 1/2	1/20	78.75
45259	PWR7480352	26125	2	1/10	109.06

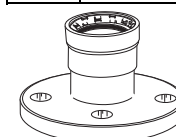

BRIDES COMPAGNONS #150					
#BMI	#Apollo	#Viega	Taille	Emballage	\$
45604	PWR7481177	25760	1/2 x 3 1/2	1/1	148.29
45605	PWR7481188	25765	3/4 x 3 7/8	1/1	155.68
45606	PWR7481199	25770	1 x 4 1/4	1/1	162.06
45607	PWR7481201	25775	1 1/4 x 4 5/8	1/1	169.25
45608	PWR7481210	25780	1 1/2 x 5	1/1	184.13
45609	PWR7481221	25785	2 x 6	1/1	227.17



RACCORDS EN ACIER AU CARBONE "PRESS" EPDM

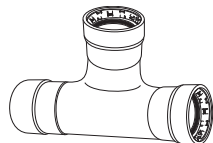

TÉS PRF x PRF x PRF					
#BMI	#Apollo	#Viega	Taille	Emballage	\$
45404	PWR7480363	25300	1/2	5/50	36.87
45405	PWR7480374	25305	3/4	5/50	40.87
45406	PWR7480385	25310	1	5/30	48.45
45407	PWR7480396	25315	1 1/4	1/14	83.20
45408	PWR7480407	25320	1 1/2	1/15	95.69
45409	PWR7480418	25325	2	1/8	156.29

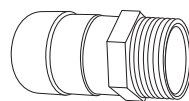

ADAPTATEURS PRF x MIPS					
#BMI	#Apollo	#Viega	Taille	Emballage	\$
45804	PWR7480847	25100	1/2	10/100	28.64
45805	PWR7480858	25105	3/4	10/80	31.05
45806	PWR7480869	25110	1	5/50	38.63
45807	PWR7480871	25115	1 1/4	5/30	47.13
45808	PWR7480880	25120	1 1/2	1/20	55.26
45809	PWR7480891	25125	2	1/20	82.06

TÉS RÉDUITS PRF x PRF x PRF					
45429	PWR7480429	25330	3/4 x 3/4 x 1/2	5/50	44.64
45439	PWR7480431	25335	1 x 1 x 1/2	5/30	55.22
45438	PWR7480440	25340	1 x 1 x 3/4	5/30	54.19
45455	PWR7483003	25510	1 1/4 x 1 1/4 x 1/2	1/15	90.18
45454	PWR7483014	25515	1 1/4 x 1 1/4 x 3/4	1/14	89.75
45453	PWR7480451	25350	1 1/4 x 1 1/4 x 1	1/15	88.26
45474	PWR7480462	25360	1 1/2 x 1 1/2 x 1/2	1/20	117.87
45473	PWR7480473	25365	1 1/2 x 1 1/2 x 3/4	1/15	113.52
45472	PWR7480484	25370	1 1/2 x 1 1/2 x 1	1/15	113.49
45471	PWR7480495	25375	1 1/2 x 1 1/2 x 1 1/4	1/15	110.95
45498	PWR7480506	25380	2 x 2 x 1/2	1/10	177.77
45497	PWR7480517	25385	2 x 2 x 3/4	1/10	172.88
45496	PWR7480528	25390	2 x 2 x 1	1/10	171.21
45495	PWR7480539	25395	2 x 2 x 1 1/4	1/10	182.50
45491	PWR7480541	25400	2 x 2 x 1 1/2	1/8	185.94

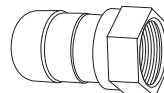

ADAPTATEURS PRF x FIPS					
45704	PWR7480902	25130	1/2	10/100	25.29
45705	PWR7480924	25135	3/4	10/100	28.38
45706	PWR7480957	25140	1	5/50	37.71
45707	PWR7480990	25145	1 1/4	5/50	44.10
45708	PWR7481045	25150	1 1/2	1/20	51.94
45709	PWR7481100	25155	2	1/20	77.78

ADAPTATEURS RÉDUITS PRF x FIPS					
45723	PWR7480913	25575	3/4 x 1/2	10/80	35.49
45728	PWR7480935	25580	1 x 1/2	10/60	45.44
45727	PWR7480946	25585	1 x 3/4	5/60	43.83
45735	PWR7480968	25590	1 1/4 x 1/2	1/50	55.95
45734	PWR7480979	25595	1 1/4 x 3/4	1/30	55.63
45733	PWR7480981	25600	1 1/4 x 1	1/25	50.86
45739	PWR7481001	25605	1 1/2 x 1/2	1/25	63.03
45738	PWR7481012	25610	1 1/2 x 3/4	1/25	61.60
45737	PWR7481023	25615	1 1/2 x 1	1/20	60.54
45736	PWR7481034	25620	1 1/2 x 1 1/4	1/20	50.86
45744	PWR7481056	25625	2 x 1/2	1/20	86.50
45743	PWR7481067	25630	2 x 3/4	1/20	86.00
45742	PWR7481078	25635	2 x 1	1/20	89.39
45741	PWR7481089	25640	2 x 1 1/4	1/20	87.90
45740	PWR7481091	25645	2 x 1 1/2	1/20	75.30

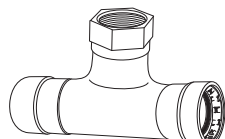

TÉS PRF x PRF x FIPS					
45630	PWR7480561	25480	3/4	5/50	47.89
45631	PWR7480550	25405	3/4 x 1/2	5/50	47.68
45641	PWR7480572	25410	1 x 1/2	5/30	54.64
45640	PWR7480583	25415	1 x 3/4	5/30	54.64
45652	PWR7480594	25485	1 1/4 x 1/2	1/20	78.01
45651	PWR7483102	25505	1 1/4 x 3/4	1/14	92.31
45650	PWR7483113	25500	1 1/4 x 1	1/14	90.05
45663	PWR7480605	25435	1 1/2 x 1/2	1/20	117.87
45662	PWR7480616	25440	1 1/2 x 3/4	1/15	111.33
45661	PWR7480627	25445	1 1/2 x 1	1/15	114.34
45660	PWR7480638	25450	1 1/2 x 1 1/4	1/15	117.99
45674	PWR7480649	25455	2 x 1/2	1/15	177.77
45673	PWR7480651	25460	2 x 3/4	1/10	171.21
45672	PWR7480660	25465	2 x 1	1/10	163.43
45671	PWR7480671	25470	2 x 1 1/4	1/15	183.87
45670	PWR7480682	25475	2 x 1 1/2	1/10	187.44

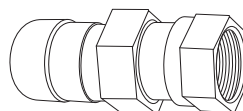

UNIONS PRF x FIPS					
45614	PWR7483245	25650	1/2	5/50	111.06
45615	PWR7483256	25655	3/4	5/25	109.19
45616	PWR7483267	25660	1	5/20	134.00
45617	PWR7483278	25665	1 1/4	1/15	168.58
45618	PWR7483289	25670	1 1/2	1/15	194.10
45619	PWR7483291	25675	2	1/8	248.98

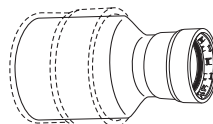

RÉDUCTEURS RACCORD x PRF					
45123	PWR7480693	26000	3/4 x 1/2	5/100	26.24
45128	PWR7480704	26005	1 x 1/2	5/80	31.10
45127	PWR7480715	26010	1 x 3/4	5/75	31.58
45131	PWR7480748	26015	1 1/4 x 1	1/40	48.34
45135	PWR7480781	26030	1 1/2 x 1 1/4	1/30	60.77
45142	PWR7480814	26035	2 x 1	1/1	78.32
45141	PWR7480825	26040	2 x 1 1/4	1/20	80.86
45140	PWR7480836	26045	2 x 1 1/2	1/20	89.83

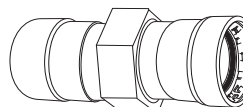

UNIONS PRF x PRF					
45104	PWR7481111	25700	1/2	5/40	122.22
45105	PWR7481122	25705	3/4	5/25	117.97
45106	PWR7481133	25710	1	5/25	144.73
45107	PWR7481144	25715	1 1/4	1/13	185.51
45108	PWR7481155	25720	1 1/2	1/13	213.60
45109	PWR7481166	25725	2	1/4	268.94



LISTE DE PRIX BMI CANADA - RACCORDS EN ACIER AU CARBONE GAZ "PRESS" HNBR

CPSG

26-1

9 février 2026

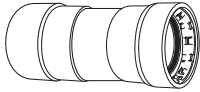

MANCHONS PRF x PRF					
#BMI	#Apollo	#Viega	Taille	Emballage	\$
46004	PWR7481298	25001	1/2	10/100	21.64
46005	PWR7481309	22009	3/4	10/100	24.84
46006	PWR7481311	25011	1	5/50	36.72
46007	PWR7481320	25016	1 1/4	1/30	47.13
46008	PWR7481331	25021	1 1/2	1/25	63.66
46009	PWR7481342	25026	2	1/20	92.47
46010	123461076	28770	2 1/2	1/1	227.92
46011	123461077	28775	3	1/1	231.41
46012	123461078	28780	4	1/1	336.64

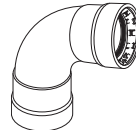

COUDES 90° PRF x PRF					
#BMI	#Apollo	#Viega	Taille	Emballage	\$
46304	PWR7481419	25201	1/2	10/80	23.46
46305	PWR7481421	25206	3/4	10/60	26.72
46306	PWR7481430	25211	1	5/30	32.45
46307	PWR7481441	25216	1 1/4	1/15	56.42
46308	PWR7481452	25221	1 1/2	1/10	72.09
46309	PWR7481463	25226	2	1/10	107.21
46310	123461058	28600	2 1/2	1/1	302.50
46311	123461059	28605	3	1/1	348.76
46312	123461060	28610	4	1/1	449.34

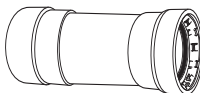

MANCHONS PRF x PRF SANS ARRÊT					
#BMI	#Apollo	#Viega	Taille	Emballage	\$
46074	PWR7481353	25031	1/2	10/100	26.36
46075	PWR7481364	25036	3/4	10/100	30.07
46076	PWR7481375	25041	1	5/50	41.53
46077	PWR7481386	25046	1 1/4	1/25	53.72
46078	PWR7481397	25051	1 1/2	1/25	70.89
46079	PWR7481408	25056	2	1/15	100.20
46080	123461073	28785	2 1/2	1/1	250.73
46081	123461074	28790	3	1/1	253.28
46082	123461075	28795	4	1/1	368.51

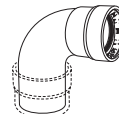

COUDES 90° RACCORD x PRF					
#BMI	#Apollo	#Viega	Taille	Emballage	\$
46354	PWR7481474	26051	1/2	10/80	23.93
46355	PWR7481485	26056	3/4	10/60	26.72
46356	PWR7481496	26061	1	5/40	32.45
46357	PWR7481507	26066	1 1/4	1/20	56.42
46358	PWR7481518	26071	1 1/2	1/15	72.09
46359	PWR7481529	26076	2	1/10	107.21
46360	123461061	28615	2 1/2	1/1	302.50
46361	123461062	28620	3	1/1	348.76
46362	123461063	28625	4	1/1	449.34

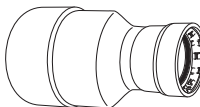

MANCHONS RÉDUITS PRF x PRF					
#BMI	#Apollo	#Viega	Taille	Emballage	\$
46023	PWR7483168	25931	3/4 x 1/2	5/20	27.30
46028	PWR7483179	25936	1 x 1/2	5/35	32.70
46027	PWR7483181	25941	1 x 3/4	5/40	32.77
46032	PWR7483190	25946	1 1/4 x 3/4	1/20	51.01
46031	PWR7483201	25951	1 1/4 x 1	1/20	51.18
46035	PWR7483212	25956	1 1/2 x 1 1/4	1/15	64.81
46041	PWR7483223	25961	2 x 1 1/4	1/15	86.23
46040	PWR7483234	25966	2 x 1 1/2	1/15	95.25



COUDES 45° PRF x PRF					
#BMI	#Apollo	#Viega	Taille	Emballage	\$
46204	PWR7481531	25231	1/2	10/100	24.46
46205	PWR7481540	25236	3/4	10/80	29.56
46206	PWR7481551	25241	1	5/50	36.94
46207	PWR7481562	25246	1 1/4	1/25	65.07
46208	PWR7481573	25251	1 1/2	1/20	81.63
46209	PWR7481584	25256	2	1/10	115.89
46210	123461052	28630	2 1/2	1/1	302.50
46211	123461053	28635	3	1/1	348.76
46212	123461054	28640	4	1/1	449.34

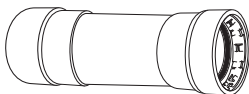

MANCHONS COULISSANTS PRF x PRF SANS ARRÊT					
#BMI	#Apollo	#Viega	Taille	Emballage	\$
46084	N/A	25071	1/2	10/50	73.73
46085	N/A	25076	3/4	10/50	79.27
46086	N/A	25081	1	5/25	92.91
46087	N/A	25086	1 1/4	1/20	100.44
46088	N/A	25091	1 1/2	1/10	103.09
46089	N/A	25096	2	1/10	106.51



COUDES 45° RACCORD x PRF					
#BMI	#Apollo	#Viega	Taille	Emballage	\$
46254	PWR7481595	26101	1/2	10/100	24.46
46255	PWR7481606	26106	3/4	10/70	29.56
46256	PWR7481617	26111	1	5/50	36.94
46257	PWR7481628	26116	1 1/4	1/30	65.07
46258	PWR7481639	26121	1 1/2	1/20	81.63
46259	PWR7481641	26126	2	1/10	115.89
46260	123461055	28645	2 1/2	1/1	302.50
46261	123461056	28650	3	1/1	348.76
46262	123461057	28655	4	1/1	449.34

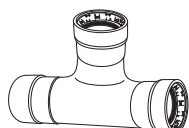

TÈS PRF x PRF x PRF					
#BMI	#Apollo	#Viega	Taille	Emballage	\$
46404	PWR7481650	25301	1/2	5/50	38.37
46405	PWR7481661	25306	3/4	5/50	42.34
46406	PWR7481672	25311	1	5/30	50.24
46407	PWR7481683	25316	1 1/4	1/14	86.24
46408	PWR7481694	25321	1 1/2	1/15	101.47
46409	PWR7481705	25326	2	1/8	164.47
46410	123461109	28660	2 1/2	1/1	434.39
46411	123461110	28665	3	1/1	495.67
46412	123461111	28670	4	1/1	566.07

TÈS RÉDUITS PRF x PRF x PRF					
#BMI	#Apollo	#Viega	Taille	Emballage	\$
46431	N/A	N/A	3/4 x 1/2 x 1/2	1/50	53.62
46429	PWR7481716	25331	3/4 x 3/4 x 1/2	5/50	46.01
46439	PWR7481727	25336	1 x 1 x 1/2	5/30	57.46
46438	PWR7481738	25341	1 x 1 x 3/4	5/30	56.19
46455	PWR7483124	25491	1 1/4 x 1 1/4 x 1/2	1/14	92.80
46454	PWR7483135	25496	1 1/4 x 1 1/4 x 3/4	1/14	92.10
46453	PWR7481749	25351	1 1/4 x 1 1/4 x 1	1/15	90.33
46474	PWR7481751	25361	1 1/2 x 1 1/2 x 1/2	1/15	125.73
46473	PWR7481760	25366	1 1/2 x 1 1/2 x 3/4	1/15	116.96
46472	PWR7481771	25371	1 1/2 x 1 1/2 x 1	1/15	118.08
46471	PWR7481782	25376	1 1/2 x 1 1/2 x 1 1/4	1/15	114.07
46498	PWR7481793	25381	2 x 2 x 1/2	1/10	189.67
46497	PWR7481804	25386	2 x 2 x 3/4	1/10	179.24
46496	PWR7481815	25391	2 x 2 x 1	1/10	177.51
46495	PWR7481826	25396	2 x 2 x 1 1/4	1/10	191.65
46491	PWR7481837	25401	2 x 2 x 1 1/2	1/8	195.45
46538	N/A	N/A	2 1/2 x 2 1/2 x 3/4	1/1	462.79
46537	123461097	28910	2 1/2 x 2 1/2 x 1	1/1	462.79
46536	123461099	28905	2 1/2 x 2 1/2 x 1 1/4	1/1	462.79
46535	123461098	28675	2 1/2 x 2 1/2 x 1 1/2	1/1	435.13
46534	123461100	28680	2 1/2 x 2 1/2 x 2	1/1	425.64
46552	123461102	28695	3 x 3 x 1 1/4	1/1	537.40
46551	123461101	28690	3 x 3 x 1 1/2	1/1	556.88
46550	123461103	28685	3 x 3 x 2	1/1	527.09
46549	123461104	28700	3 x 3 x 2 1/2	1/1	543.75
46572	123461106	28710	4 x 4 x 2	1/1	659.83
46571	123461107	28715	4 x 4 x 2 1/2	1/1	688.51
46570	123461108	28720	4 x 4 x 3	1/1	693.35

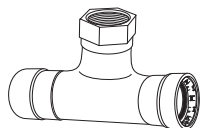

TÈS PRF x PRF x FIPS					
#BMI	#Apollo	#Viega	Taille	Emballage	\$
46630	PWR7481859	25481	3/4	5/50	49.93
46631	PWR7481848	25406	3/4 x 3/4 x 1/2	5/50	47.63
46641	PWR7481861	25411	1 x 1 x 1/2	5/30	54.14
46640	PWR7481870	25416	1 x 1 x 3/4	5/30	53.62
46652	PWR7481881	25486	1 1/4 x 1 1/4 x 1/2	1/20	79.06
46651	PWR7483146	25506	1 1/4 x 1 1/4 x 3/4	1/14	94.22
46650	PWR7483157	25501	1 1/4 x 1 1/4 x 1	1/14	102.09
46663	PWR7481892	25436	1 1/2 x 1 1/2 x 1/2	1/20	128.11
46662	PWR7481903	25441	1 1/2 x 1 1/2 x 3/4	1/15	118.76
46661	PWR7481914	25446	1 1/2 x 1 1/2 x 1	1/15	121.79
46660	PWR7481925	25451	1 1/2 x 1 1/2 x 1 1/4	1/15	124.78
46674	PWR7481936	25456	2 x 2 x 1/2	1/15	178.76
46673	PWR7481947	25461	2 x 2 x 3/4	1/10	177.08
46672	PWR7481958	25466	2 x 2 x 1	1/10	179.29
46671	PWR7481969	25471	2 x 2 x 1 1/4	1/15	195.46
46670	PWR7481971	25476	2 x 2 x 1 1/2	1/10	198.04

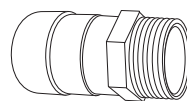

ADAPTATEURS PRF x MIPS					
#BMI	#Apollo	#Viega	Taille	Emballage	\$
46804	PWR7482081	25101	1/2	10/100	30.07
46805	PWR7482090	25106	3/4	10/80	32.69
46806	PWR7482101	25111	1	5/50	40.94
46807	PWR7482112	25116	1 1/4	5/50	49.46
46808	PWR7482123	25121	1 1/2	1/20	58.02
46809	PWR7482134	25126	2	1/20	88.37
46810	123461067	28740	2 1/2	1/1	274.34
46811	123461068	28745	3	1/1	352.50
46812	123461069	28750	4	1/1	422.14

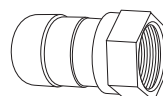

ADAPTATEURS PRF x FIPS					
#BMI	#Apollo	#Viega	Taille	Emballage	\$
46704	PWR7482145	25131	1/2	10/100	26.97
46705	PWR7482167	25136	3/4	10/100	30.87
46706	PWR7482191	25141	1	5/50	40.62
46707	PWR7482233	25146	1 1/4	5/50	48.86
46708	PWR7482288	25151	1 1/2	1/20	56.43
46709	PWR7482343	25156	2	1/20	84.52
46710	123461064	28755	2 1/2	1/1	260.27
46711	123461065	28760	3	1/1	314.66
46712	123461066	28765	4	1/1	434.53

ADAPTATEURS RÉDUITS PRF x FIPS					
#BMI	#Apollo	#Viega	Taille	Emballage	\$
46723	PWR7482156	25576	3/4 x 1/2	10/80	38.28
46728	PWR7482178	25581	1 x 1/2	10/60	47.24
46727	PWR7482189	25586	1 x 3/4	5/60	49.54
46735	PWR7482200	25591	1 1/4 x 1/2	1/50	60.56
46734	PWR7482211	25596	1 1/4 x 3/4	1/30	60.22
46733	PWR7482222	25601	1 1/4 x 1	1/25	59.17
46739	PWR7482244	25606	1 1/2 x 1/2	1/25	67.10
46738	PWR7482255	25611	1 1/2 x 3/4	1/25	64.10
46737	PWR7482266	25616	1 1/2 x 1	1/20	65.40
46736	PWR7482277	25621	1 1/2 x 1 1/4	1/20	62.69
46744	PWR7482299	25626	2 x 1/2	1/20	91.79
46742	PWR7482310	25636	2 x 1	1/10	93.95
46741	PWR7482321	25641	2 x 1 1/4	1/20	92.21
46740	PWR7482332	25646	2 x 1 1/2	1/20	86.57

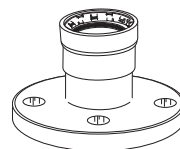

BRIDES COMPAGNONS #150					
#BMI	#Apollo	#Viega	Taille	Emballage	\$
46604	PWR7482411	25761	09 février 202	1/1	148.90
46605	PWR7482420	25766	3/4 x 3 7/8	1/1	156.00
46606	PWR7482431	25771	1 x 4 1/4	1/1	162.65
46607	PWR7482442	25776	1 1/4 x 4 5/8	1/1	170.51
46608	PWR7482453	25781	1 1/2 x 5	1/1	203.85
46609	PWR7482464	25786	2 x 6	1/1	255.81
46610	N/A	28875	2 1/2 x 7	1/1	327.84
46611	N/A	28880	3 x 7 1/2	1/1	410.78
46612	N/A	28885	4 x 9	1/1	459.33

RACCORDS EN ACIER AU CARBONE GAZ "PRESS" HNBR

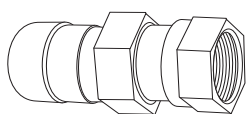

UNIONS PRF x FIPS					
#BMI	#Apollo	#Viega	Taille	Emballage	\$
46614	PWR7483300	25651	1/2	5/50	119.93
46615	PWR7483311	25656	3/4	5/25	117.91
46616	PWR7483322	25661	1	5/20	144.70
46617	PWR7483333	25666	1 1/4	1/10	182.03
46618	PWR7483344	25671	1 1/2	1/10	209.64
46619	PWR7483355	25676	2	1/8	268.91

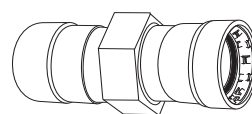

UNIONS PRF x PRF					
#BMI	#Apollo	#Viega	Taille	Emballage	\$
46104	PWR7482354	25701	1/2	5/40	127.17
46105	PWR7482365	25706	3/4	5/25	125.04
46106	PWR7482376	25711	1	5/25	153.46
46107	PWR7482387	25716	1 1/4	1/13	197.90
46108	PWR7482398	25721	1 1/2	1/13	227.90
46109	PWR7482409	25726	2	1/3	285.16

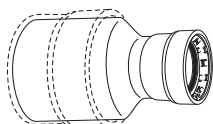

RÉDUCTEURS RACCORD x PRF					
#BMI	#Apollo	#Viega	Taille	Emballage	\$
46123	PWR7481980	26001	3/4 x 1/2	5/10	27.30
46128	PWR7481991	26006	1 x 1/2	5/80	32.70
46127	PWR7482002	26011	1 x 3/4	5/75	32.77
46131	PWR7482013	26016	1 1/4 x 1	1/40	51.24
46137	PWR7482024	26021	1 1/2 x 3/4	1/35	61.58
46136	PWR7482035	26031	1 1/2 x 1	1/35	61.83
46135	PWR7482046	26026	1 1/2 x 1 1/4	1/30	64.81
46142	PWR7482057	26036	2 x 1	1/30	83.55
46141	PWR7482068	26041	2 x 1 1/4	1/20	86.23
46140	PWR7482079	26046	2 x 1 1/2	1/20	95.25
46148	123461081	28805	2 1/2 x 1 1/4	1/1	217.09
46147	123461080	28810	2 1/2 x 1 1/2	1/1	213.54
46146	123461082	28815	2 1/2 x 2	1/1	211.46
46154	123461084	28820	3 x 1 1/4	1/1	279.87
46153	123461083	28825	3 x 1 1/2	1/1	279.87
46152	123461085	28830	3 x 2	1/1	276.72
46151	123461086	28835	3 x 2 1/2	1/1	276.72
46159	123461087	28840	4 x 1 1/2	1/1	339.94
46158	123461088	28845	4 x 2	1/1	337.65
46156	123461090	28855	4 x 3	1/1	319.94

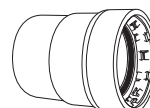

CAPUCHONS					
#BMI	#Apollo	#Viega	Taille	Emballage	\$
46504	PWR7482475	25731	1/2	10/120	26.81
46505	PWR7482486	25736	3/4	10/100	28.04
46506	PWR7482497	25741	1	5/75	31.69
46507	PWR7482508	25746	1 1/4	1/50	54.16
46508	PWR7482519	25751	1 1/2	1/25	69.20
46509	PWR7482521	25756	2	1/20	85.50
46510	123461070	28860	2 1/2	1/1	224.96
46511	123461071	28865	3	1/1	266.93
46512	123461072	28870	4	1/1	361.86



LISTE DE PRIX BMI CANADA - VALVES À BILLE EN ACIER AU CARBONE "PRESS"

CBV
26-1

9 mars 2026

VALVES À BILLE "PRESS" À GAZ - CORPS EN LAITON/ACIER AU CARBONE

CATÉGORIE BMI 49 - VALVES À BILLE CARBON PRESS LAITON/ACIER



PRESS x PRESS PLEIN DÉBIT					
#BMI	#Apollo	#Viega	Taille	Emballage	\$
49004	N/A	30600	1/2	6/60	95.42
49005	N/A	30605	3/4	4/40	113.36
49006	N/A	30610	1	4/24	155.23
49007	N/A	30615	1 1/4	2/16	204.94
49008	N/A	30620	1 1/2	2/8	254.30
49009	N/A	30625	2	1/6	390.18

PRESS x FIPS PLEIN DÉBIT					
#BMI	#Apollo	#Viega	Taille	Emballage	\$
49104	N/A	30630	1/2	6/60	98.76
49105	N/A	30635	3/4	4/40	117.33
49106	N/A	30640	1	4/24	160.66
49107	N/A	30645	1 1/4	2/16	212.11
49108	N/A	30650	1 1/2	2/8	263.20
49109	N/A	30655	2	1/6	403.84

PRESS x MIPS PLEIN DÉBIT					
#BMI	#Apollo	#Viega	Taille	Emballage	\$
49204	N/A	30660	1/2	6/60	98.76
49205	N/A	30665	3/4	4/40	117.33
49206	N/A	30670	1	4/24	160.66
49207	N/A	30675	1 1/4	2/16	212.11
49208	N/A	30680	1 1/2	2/8	263.20
49209	N/A	30685	2	1/6	403.84



VALVES À BILLE "PRESS" À GAZ - CORPS EN ACIER AU CARBONE

CATÉGORIE BMI 60 - VALVES À BILLE CARBON PRESS EN ACIER



PRESS x PRESS PLEIN DÉBIT					
#BMI	#Apollo	#Viega	Taille	Emballage	\$
60004	89FVH4301	N/A	1/2	6/60	99.97
60005	89FVH4401	N/A	3/4	4/40	118.75
60006	89FVH4501	N/A	1	4/24	162.63
60007	89FVH4601	N/A	1 1/4	2/16	214.70
60008	89FVH4701	N/A	1 1/2	2/8	266.41
60009	89FVH4801	N/A	2	1/6	408.76

PRESS x FIPS PLEIN DÉBIT					
#BMI	#Apollo	#Viega	Taille	Emballage	\$
60104	N/A	N/A	1/2	6/60	103.47
60105	N/A	N/A	3/4	4/40	122.91
60106	N/A	N/A	1	4/24	168.32
60107	N/A	N/A	1 1/4	2/16	222.21
60108	N/A	N/A	1 1/2	2/8	275.73
60109	N/A	N/A	2	1/6	423.07

PRESS x MIPS PLEIN DÉBIT					
#BMI	#Apollo	#Viega	Taille	Emballage	\$
60204	N/A	N/A	1/2	6/60	103.47
60205	N/A	N/A	3/4	4/40	122.91
60206	N/A	N/A	1	4/24	168.32
60207	N/A	N/A	1 1/4	2/16	222.21
60208	N/A	N/A	1 1/2	2/8	275.73
60209	N/A	N/A	2	1/6	423.07



VALVES À BILLE "PRESS" - CORPS EN ACIER AU CARBONE

CATÉGORIE BMI 60 - VALVES À BILLE CARBON PRESS EN ACIER



PRESS x PRESS PLEIN DÉBIT					
#BMI	#Apollo	#Viega	Taille	Emballage	\$
60024	89FVE4301	28915	1/2	6/60	95.28
60025	89FVE4401	28920	3/4	4/40	112.93
60026	89FVE4501	28925	1	4/24	153.87
60027	89FVE4601	28930	1 1/4	2/16	204.39
60028	89FVE4701	28935	1 1/2	2/8	253.50
60029	89FVE4801	28940	2	1/6	383.43

PRESS x FIPS PLEIN DÉBIT					
#BMI	#Apollo	#Viega	Taille	Emballage	\$
60124	N/A	N/A	1/2	6/60	98.61
60125	N/A	N/A	3/4	4/40	116.88
60126	N/A	N/A	1	4/24	159.26
60127	N/A	N/A	1 1/4	2/16	211.54
60128	N/A	N/A	1 1/2	2/8	262.37
60129	N/A	N/A	2	1/6	396.85

PRESS x MIPS PLEIN DÉBIT					
#BMI	#Apollo	#Viega	Taille	Emballage	\$
60224	N/A	N/A	1/2	6/60	98.61
60225	N/A	N/A	3/4	4/40	116.88
60226	N/A	N/A	1	4/24	159.26
60227	N/A	N/A	1 1/4	2/16	211.54
60228	N/A	N/A	1 1/2	2/8	262.37
60229	N/A	N/A	2	1/6	396.85





LISTE DE PRIX BMI CANADA - RACCORDS
EN FONTE MALLÉABLE CLASSE 150

**MAC
25-1**

12 mars 2025 (b)

LISTE MAC 25-1

12 mars 2025 (b)

Liste de prix BMI Canada remplace MAC 22-2



ISO 9001
ISO 14001



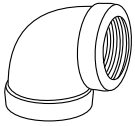

COUDES 90°					
#BMI		Taille	Emballage	\$	
NOIR	GALV.			NOIR	GALV.
35301	36301	1/8	50/600	44.00	59.70
35302	36302	1/4	35/420	37.91	45.94
35303	36303	3/8	90/360	37.91	45.94
35304	36304	1/2	50/200	30.86	37.61
35305	36305	3/4	35/105	44.63	54.30
35306	36306	1	20/60	68.52	83.62
35307	36307	1 1/4	20/40	102.92	125.29
35308	36308	1 1/2	15/30	137.16	167.12
35309	36309	2	8/16	205.80	250.73
35310	36310	2 1/2	1/12	399.34	482.45
35311	36311	3	1/8	608.45	735.26
35312	36312	4	1/2	1 103.26	1 332.62
35313	-	5	1/2	3 043.16	-
35314	36314	6	1/1	4 374.36	5 284.64

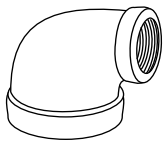

COUDES RÉDUITS - 90°					
#BMI		Taille	Emballage	\$	
35315	-	1/4 x 1/8	40/480	45.43	-
35316	36316	3/8 x 1/4	90/360	45.43	66.63
35317	-	3/8 x 1/8	105/420	45.43	-
35319	36319	1/2 x 3/8	60/240	41.73	50.64
35320	36320	1/2 x 1/4	60/240	41.73	50.64
35321	36321	1/2 x 1/8	80/240	41.73	50.64
35323	36323	3/4 x 1/2	40/120	55.18	66.63
35324	36324	3/4 x 3/8	40/160	55.18	66.63
35325	36325	3/4 x 1/4	40/160	55.18	66.63
35326	36326	3/4 x 1/8	40/160	55.18	73.60
35327	36327	1 x 3/4	50/100	83.83	101.25
35328	36328	1 x 1/2	25/100	83.83	101.25
35331	36331	1 1/4 x 1	10/40	135.08	163.02
35332	36332	1 1/4 x 3/4	15/60	135.08	163.02
35333	36333	1 1/4 x 1/2	20/80	135.08	163.02
35335	36335	1 1/2 x 1 1/4	15/30	167.41	202.10
35336	36336	1 1/2 x 1	10/40	167.41	202.10
35337	36337	1 1/2 x 3/4	10/40	167.41	202.10
35338	36338	1 1/2 x 1/2	15/60	167.41	202.10
35340	36340	2 x 1 1/2	10/20	247.50	298.87
35341	36341	2 x 1 1/4	10/20	247.50	298.87
35342	36342	2 x 1	14/28	247.50	298.87
35343	36343	2 x 3/4	9/36	247.50	298.87
35344	36344	2 x 1/2	10/40	247.50	298.87

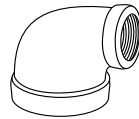

COUDES RÉDUITS - 90°					
#BMI		Taille	Emballage	\$	
NOIR	GALV.			NOIR	GALV.
35346	36346	2 1/2 x 2	6/12	513.53	753.14
35347	36347	2 1/2 x 1 1/2	6/12	513.53	753.14
35348	-	2 1/2 x 1 1/4	8/16	513.53	-
35349	-	2 1/2 x 1	8/16	458.51	-
35351	36351	3 x 2 1/2	4/8	857.57	1 712.20
35352	36352	3 x 2	4/8	857.57	1 712.20
-	36353	3 x 1 1/2	4/8	-	1 712.20

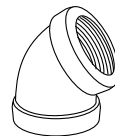

COUDES 45°					
#BMI		Taille	Emballage	\$	
35201	36201	1/8	50/600	46.00	62.00
35202	36202	1/4	30/360	41.73	50.64
35203	36203	3/8	75/300	41.73	50.64
35204	36204	1/2	50/200	30.86	37.61
35205	36205	3/4	40/120	46.41	56.31
35206	36206	1	20/60	68.52	83.62
35207	36207	1 1/4	20/40	111.69	135.78
35208	36208	1 1/2	10/30	137.16	167.12
35209	36209	2	12/24	205.80	250.73
35210	36210	2 1/2	1/12	475.42	574.49
35211	36211	3	1/10	722.84	873.33
-	36215	3 1/2	1/10	-	1 712.07
35212	36212	4	2/4	1 236.39	1 493.26
35214	36214	6	1/1	7 015.24	8 560.10

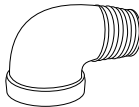

COUDES 90° (MxF)					
#BMI		Taille	Emballage	\$	
35371	36371	1/8	60/720	49.50	66.69
35372	36372	1/4	35/420	41.73	50.64
35373	36373	3/8	60/240	41.73	50.64
35374	36374	1/2	60/180	37.91	45.94
35375	36375	3/4	35/105	55.18	66.63
35376	36376	1	45/90	81.98	98.97
35377	36377	1 1/4	25/50	142.74	172.38
35378	36378	1 1/2	9/27	174.97	211.55
35379	36379	2	8/16	247.50	298.87
35380	36380	2 1/2	5/10	551.72	666.31
35381	36381	3	1/8	855.81	1 034.04
35382	36382	4	1/4	1 426.43	1 723.31



COUDES 45° (MxF)					
#BMI		Taille	Emballage	\$	
NOIR	GALV.			NOIR	GALV.
35271	36271	1/8	70/840	78.00	105.15
35272	36272	1/4	40/480	57.10	85.68
35273	36273	3/8	100/400	57.10	85.68
35274	36274	1/2	75/225	57.10	69.07
35275	36275	3/4	40/120	87.49	105.66
35276	36276	1	25/75	115.94	140.20
35277	36277	1 1/4	10/40	190.38	229.64
35278	36278	1 1/2	10/30	228.07	275.64
35279	36279	2	12/24	380.39	459.59
35280	-	2 1/2	6/12	760.63	-
35281	-	3	3/6	1141.24	-
35283	36283	4	1/4	1711.63	4587.27

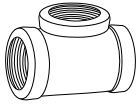

TÉS					
#BMI		Taille	Emballage	\$	
35401	36401	1/8	120/480	56.00	75.00
35402	36402	1/4	75/300	47.73	57.51
35403	36403	3/8	45/180	47.73	57.51
35404	36404	1/2	40/120	39.48	47.89
35405	36405	3/4	35/70	56.48	68.99
35406	36406	1	20/40	89.08	108.61
35407	36407	1 1/4	14/28	133.85	162.87
35408	36408	1 1/2	12/24	171.53	209.00
35409	36409	2	8/16	257.32	313.31
35410	36410	2 1/2	4/8	608.45	735.26
35411	36411	3	1/6	798.81	964.99
-	36415	3 1/2	1/4	-	3424.14
35412	36412	4	1/2	1445.53	1746.08
35413	-	5	1/1	3803.73	-
35414	36414	6	1/1	5135.08	6203.39

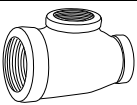

TÉS RÉDUITS					
1/4" & 3/8"					
#BMI		Taille	Emballage	\$	
35523	-	1/4 x 1/4 x 1/8	25/300	82.98	-
35417	36417	3/8 x 3/8 x 1/4	60/240	76.37	102.79
1/2"					
35419	36419	1/2 x 1/2 x 1	25/100	119.76	145.51
35420	36420	1/2 x 1/2 x 3/4	30/120	78.04	94.19
35421	36421	1/2 x 1/2 x 3/8	40/160	64.75	78.04
35422	36422	1/2 x 1/2 x 1/4	40/160	64.75	78.04
-	36424	1/2 x 3/8 x 1/2	80/160	-	78.04
3/4"					
35427	36427	3/4 x 3/4 x 1	40/80	119.76	144.79
35429	36429	3/4 x 3/4 x 1/2	20/80	70.40	102.79
35434	36434	3/4 x 3/4 x 3/8	25/100	81.22	102.79
35428	36428	3/4 x 3/4 x 1/4	25/100	78.04	102.79
35432	-	3/4 x 1/2 x 1	20/80	119.76	-
35430	36430	3/4 x 1/2 x 3/4	20/80	78.04	94.19
35433	36433	3/4 x 1/2 x 1/2	24/72	78.04	94.19

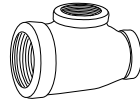

TÉS RÉDUITS					
#BMI		Taille	Emballage	\$	
1"					
35436	36436	1 x 1 x 1 1/2	9/36	228.07	275.64
35437	36437	1 x 1 x 1 1/4	11/44	180.57	218.20
35438	36438	1 x 1 x 3/4	12/48	107.96	131.60
35440	36440	1 x 1 x 1/2	15/60	107.96	131.60
35439	36439	1 x 1 x 3/8	15/60	119.76	144.79
35441	36441	1 x 1 x 1/4	20/80	119.76	144.79
35442	36442	1 x 3/4 x 1	30/60	119.76	144.79
35443	36443	1 x 3/4 x 3/4	15/60	119.76	144.79
35445	36445	1 x 3/4 x 1/2	20/80	119.76	144.79
35448	36448	1 x 1/2 x 1	15/60	119.76	144.79
35449	36449	1 x 1/2 x 3/4	20/80	119.76	144.79
35450	36450	1 x 1/2 x 1/2	20/80	119.76	144.79
1 1/4"					
35451	36451	1 1/4 x 1 1/4 x 1 1/2	12/24	228.07	275.64
35453	36453	1 1/4 x 1 1/4 x 1	20/40	180.57	218.20
35454	36454	1 1/4 x 1 1/4 x 3/4	20/40	180.57	218.20
35455	36455	1 1/4 x 1 1/4 x 1/2	20/40	180.57	218.20
35457	36457	1 1/4 x 1 x 1 1/4	15/30	180.57	218.20
35458	36458	1 1/4 x 1 x 1	20/40	180.57	218.20
35459	36459	1 1/4 x 1 x 3/4	20/40	163.05	218.20
35460	36460	1 1/4 x 1 x 1/2	20/40	180.57	218.20
35461	36461	1 1/4 x 3/4 x 1 1/4	20/40	180.57	218.20
35462	36462	1 1/4 x 3/4 x 1	10/40	180.57	218.20
35463	-	1 1/4 x 3/4 x 3/4	10/40	180.57	-
35464	-	1 1/4 x 3/4 x 1/2	10/40	163.05	-
35465	36465	1 1/4 x 1/2 x 1 1/4	20/40	180.57	218.20
35466	-	1 1/4 x 1/2 x 1	20/40	180.57	-
35467	-	1 1/4 x 1/2 x 3/4	25/50	180.57	-
35468	-	1 1/4 x 1/2 x 1/2	25/50	180.57	-
1 1/2"					
35471	36471	1 1/2 x 1 1/2 x 1 1/4	12/24	228.07	275.64
35472	36472	1 1/2 x 1 1/2 x 1	15/30	228.07	275.64
35473	36473	1 1/2 x 1 1/2 x 3/4	15/30	205.80	250.73
35474	36474	1 1/2 x 1 1/2 x 1/2	18/36	228.07	275.64
35475	36475	1 1/2 x 1 1/4 x 1 1/2	12/24	228.07	275.64
35476	36476	1 1/2 x 1 1/4 x 1 1/4	12/24	228.07	275.64
35477	36477	1 1/2 x 1 1/4 x 1	12/24	228.07	275.64
35478	36478	1 1/2 x 1 1/4 x 3/4	12/24	228.07	275.64
35479	36479	1 1/2 x 1 1/4 x 1/2	12/24	228.07	275.64
35480	-	1 1/2 x 1 x 1 1/2	12/24	228.07	-
35481	-	1 1/2 x 1 x 1 1/4	12/24	228.07	-
35482	36482	1 1/2 x 1 x 1	15/30	228.07	275.64
35483	-	1 1/2 x 1 x 3/4	15/30	228.07	-
35485	36485	1 1/2 x 3/4 x 1 1/2	12/24	228.07	275.64
35486	36486	1 1/2 x 3/4 x 1 1/4	12/24	228.07	275.64
35487	-	1 1/2 x 3/4 x 1	12/24	228.07	-
35488	-	1 1/2 x 3/4 x 3/4	15/30	228.07	-
35489	-	1 1/2 x 3/4 x 1/2	15/30	203.63	-
35490	36490	1 1/2 x 1/2 x 1 1/2	12/24	228.07	275.64
-	36492	1 1/2 x 1/2 x 1	18/36	-	275.77

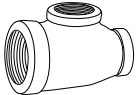

TÉS RÉDUITS					
#BMI		Taille	Emballage	\$	
NOIR	GALV.			NOIR	GALV.
2"					
35494	36494	2 x 2 x 1 1/2	8/16	323.24	390.64
35495	36495	2 x 2 x 1 1/4	8/16	323.24	390.64
35496	36496	2 x 2 x 1	10/20	291.48	355.13
35497	36497	2 x 2 x 3/4	10/20	291.48	355.13
35498	36498	2 x 2 x 1/2	10/20	323.24	390.64
35530	36530	2 x 1 1/2 x 2	8/16	323.24	390.64
35531	36531	2 x 1 1/2 x 1 1/2	8/16	323.24	390.64
35532	36532	2 x 1 1/2 x 1 1/4	8/16	323.24	390.64
35533	36533	2 x 1 1/2 x 1	10/20	323.24	390.64
35534	-	2 x 1 1/2 x 3/4	10/20	323.24	-
35540	-	2 x 1 1/4 x 2	8/16	323.24	-
35541	36541	2 x 1 1/4 x 1 1/2	8/16	323.24	390.64
35542	36542	2 x 1 1/4 x 1 1/4	8/16	323.24	390.64
35550	36550	2 x 1 x 2	8/16	323.24	390.64
35553	36553	2 x 1 x 1	12/24	323.24	390.64
35560	36560	2 x 3/4 x 2	8/16	323.24	390.64
35562	-	2 x 3/4 x 3/4	5/15	323.24	-
35561	36561	2 x 1/2 x 2	8/16	323.24	390.64
2 1/2"					
35570	36570	2 1/2 x 2 1/2 x 2	4/8	665.80	804.23
35571	36571	2 1/2 x 2 1/2 x 1 1/2	5/10	665.80	804.23
35572	36572	2 1/2 x 2 1/2 x 1 1/4	5/10	665.80	804.23
35573	36573	2 1/2 x 2 1/2 x 1	5/10	665.80	804.23
35574	36574	2 1/2 x 2 1/2 x 3/4	6/12	665.80	804.23
35575	36575	2 1/2 x 2 1/2 x 1/2	6/12	665.80	804.23
35577	-	2 1/2 x 3/4 x 2 1/2	1/15	1330.17	-
3"					
35580	36580	3 x 3 x 2 1/2	3/6	950.91	1148.81
35581	36581	3 x 3 x 2	3/6	950.91	1148.81
35582	36582	3 x 3 x 1 1/2	3/6	950.91	1148.81
35583	-	3 x 3 x 1 1/4	3/6	950.91	-
35584	-	3 x 3 x 1	3/6	950.91	-
4"					
35588	36588	4 x 4 x 3	1/2	1806.73	2182.88
35589	36589	4 x 4 x 2 1/2	3/6	1806.73	2182.88
35590	36590	4 x 4 x 2	1/3	1806.73	2182.88

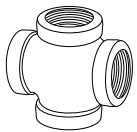

CROIX					
35622	36622	1/4	60/240	95.22	114.98
35623	36623	3/8	50/150	95.22	114.98
35624	36624	1/2	30/90	95.22	114.98
35625	36625	3/4	20/60	132.97	160.88
35626	36626	1	15/30	180.57	218.20
35627	36627	1 1/4	10/20	266.41	321.55
35628	36628	1 1/2	8/16	361.37	436.62
35629	36629	2	5/10	494.55	597.41
35630	36630	2 1/2	3/6	1075.78	1403.83
35631	-	3	1/4	1527.96	-
35620	-	4	1/2	2837.25	-

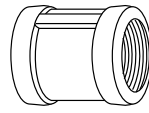

MANCHONS					
#BMI		Taille	Emballage	\$	
NOIR	GALV.			NOIR	GALV.
35001	36001	1/8	70/840	30.75	41.00
35002	36002	1/4	40/480	28.49	34.59
35003	36003	3/8	60/240	28.49	34.59
35004	36004	1/2	60/240	24.05	29.40
35005	36005	3/4	50/150	32.55	39.60
35006	36006	1	25/100	55.01	66.83
35007	36007	1 1/4	16/64	77.28	94.01
35008	36008	1 1/2	18/36	94.38	114.98
35009	36009	2	12/24	145.87	177.68
35010	36010	2 1/2	8/16	285.33	344.84
35011	36011	3	1/12	418.39	505.34
35012	36012	4	3/6	684.53	827.25
35013	-	5	1/2	1616.74	-
35014	36014	6	1/2	2092.12	2527.20

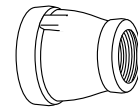

MANCHONS RÉDUITS					
1/4", 3/8", 1/2"					
35015	36015	1/4 x 1/8	50/600	32.32	39.16
35016	36016	3/8 x 1/4	30/360	32.32	39.16
35017	36017	3/8 x 1/8	35/420	32.32	39.16
35019	36019	1/2 x 3/8	60/240	32.32	39.16
35020	36020	1/2 x 1/4	75/300	32.32	39.16
35021	36021	1/2 x 1/8	75/300	32.32	39.16
3/4"					
35023	36023	3/4 x 1/2	60/180	41.15	50.13
35024	36024	3/4 x 3/8	45/180	45.43	55.15
35025	36025	3/4 x 1/4	45/180	45.43	55.15
35026	36026	3/4 x 1/8	70/210	45.43	55.15
1"					
35027	36027	1 x 3/4	25/100	55.01	66.83
35028	36028	1 x 1/2	30/120	60.76	73.36
35029	36029	1 x 3/8	30/120	60.76	73.36
35030	36030	1 x 1/4	45/135	60.76	73.36
1 1/4"					
35031	36031	1 1/4 x 1	15/60	89.36	107.92
35032	36032	1 1/4 x 3/4	25/75	89.36	107.92
35033	36033	1 1/4 x 1/2	25/75	89.36	107.92
35063	-	1 1/4 x 1/4	25/75	89.36	-
1 1/2"					
35035	36035	1 1/2 x 1 1/4	12/48	106.62	128.89
35036	36036	1 1/2 x 1	25/50	106.62	128.89
35037	36037	1 1/2 x 3/4	15/60	106.62	128.89
35038	36038	1 1/2 x 1/2	20/60	106.62	128.89
35080	-	1 1/2 x 1/4	20/60	119.86	-
2"					
35040	36040	2 x 1 1/2	9/27	161.68	195.33
35041	36041	2 x 1 1/4	9/27	161.68	195.33
35042	36042	2 x 1	12/36	161.68	195.33
35043	36043	2 x 3/4	12/36	161.68	195.33
35044	36044	2 x 1/2	12/36	161.68	195.33

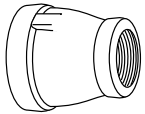

MANCHONS RÉDUITS					
#BMI		Taille	Emballage	\$	
NOIR	GALV.			NOIR	GALV.
2 1/2"					
35046	36046	2 1/2 x 2	7/14	304.17	367.55
35047	36047	2 1/2 x 1 1/2	7/14	304.17	367.55
35048	36048	2 1/2 x 1 1/4	10/20	304.17	367.55
35049	36049	2 1/2 x 1	10/20	304.17	367.55
3"					
35051	36051	3 x 2 1/2	5/10	475.42	574.49
35052	36052	3 x 2	6/12	475.42	574.49
35053	36053	3 x 1 1/2	6/12	475.42	574.49
35054	-	3 x 1 1/4	6/12	475.42	-
35055	36055	3 x 1	6/12	475.42	574.49
4"					
35056	36056	4 x 3	3/6	874.84	1056.75
35057	36057	4 x 2 1/2	3/6	874.84	1056.75
35058	36058	4 x 2	3/6	874.84	1056.75
35059	36059	4 x 1 1/2	3/6	874.84	1056.75
6"					
35070	-	6 x 4	1/2	2961.91	-

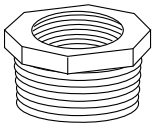

RÉDUCTEURS HEXAGONAUX					
1/4", 3/8", 1/2"					
35115	36115	1/4 x 1/8	120/1440	48.75	76.20
35116	36116	3/8 x 1/4	75/900	48.75	76.20
35117	36117	3/8 x 1/8	75/900	48.75	76.20
35119	36119	1/2 x 3/8	150/600	28.49	34.59
35120	36120	1/2 x 1/4	150/600	28.49	34.59
35121	36121	1/2 x 1/8	150/600	28.49	34.59
3/4"					
35123	36123	3/4 x 1/2	75/300	32.32	39.16
35124	36124	3/4 x 3/8	75/300	32.32	39.16
35125	36125	3/4 x 1/4	75/300	32.32	39.16
35126	36126	3/4 x 1/8	75/300	32.32	39.16
1"					
35127	36127	1 x 3/4	50/200	42.95	52.16
35128	36128	1 x 1/2	50/200	42.95	52.16
35129	36129	1 x 3/8	50/200	47.73	57.66
35130	36130	1 x 1/4	50/200	47.73	57.66
35131	-	1 x 1/8	50/200	54.62	-
1 1/4"					
35132	36132	1 1/4 x 1	30/120	68.52	83.62
35133	36133	1 1/4 x 3/4	30/120	76.17	91.94
35134	36134	1 1/4 x 1/2	30/120	76.17	91.94
35169	36169	1 1/4 x 3/8	30/120	76.17	91.94
35170	36170	1 1/4 x 1/4	30/120	76.17	91.94

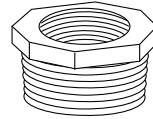

RÉDUCTEURS HEXAGONAUX					
#BMI		Taille	Emballage	\$	
NOIR	GALV.			NOIR	GALV.
1 1/2"					
35136	36136	1 1/2 x 1 1/4	25/75	89.36	107.92
35137	36137	1 1/2 x 1	25/75	89.36	107.92
35138	36138	1 1/2 x 3/4	25/75	89.36	107.92
35139	36139	1 1/2 x 1/2	25/75	89.36	107.92
35179	36179	1 1/2 x 3/8	25/75	89.36	107.92
35180	36180	1 1/2 x 1/4	25/75	89.36	107.92
35181	-	1 1/2 x 1/8	25/75	89.36	-
2"					
35140	36140	2 x 1 1/2	20/60	111.69	135.78
35141	36141	2 x 1 1/4	20/60	111.69	135.78
35142	36142	2 x 1	20/60	123.57	149.12
35143	36143	2 x 3/4	20/60	123.57	149.12
35144	36144	2 x 1/2	20/60	123.57	149.12
35145	36145	2 x 3/8	20/60	123.57	149.12
35182	36182	2 x 1/4	30/60	123.57	149.12
2 1/2"					
35146	36146	2 1/2 x 2	15/30	209.08	252.75
35147	36147	2 1/2 x 1 1/2	15/30	209.08	252.75
35148	36148	2 1/2 x 1 1/4	15/30	209.08	252.75
35149	36149	2 1/2 x 1	15/30	209.08	252.75
35150	36150	2 1/2 x 3/4	15/30	209.08	252.75
35191	36191	2 1/2 x 1/2	15/30	209.08	252.75
3"					
35151	36151	3 x 2 1/2	12/24	304.17	367.55
35152	36152	3 x 2	12/24	304.17	367.55
35153	36153	3 x 1 1/2	12/24	304.17	367.55
35154	36154	3 x 1 1/4	12/24	304.17	367.55
35155	36155	3 x 1	12/24	304.17	367.55
3 1/2"					
35193	-	3 1/2 x 3	8/16	779.40	-
35196	36196	3 1/2 x 1 1/2	8/16	721.65	1 198.48
4"					
35156	36156	4 x 3	5/10	570.49	689.32
35157	36157	4 x 2 1/2	5/10	570.49	689.32
35158	36158	4 x 2	5/10	570.49	689.32
35159	36159	4 x 1 1/2	5/10	570.49	689.32
35160	-	4 x 1 1/4	5/10	528.24	-
35161	36161	4 x 1	5/10	570.49	689.32
5"					
35197	-	5 x 4	2/4	1 558.93	-
6"					
35167	-	6 x 5	2/4	1 558.93	-
35165	36165	6 x 4	2/4	1 558.93	2 054.35
35166	36166	6 x 3	2/4	1 558.93	2 054.35
35168	-	6 x 2	2/4	1 558.93	-

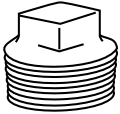

BOUCHONS À TÊTES CARRÉES					
#BMI		Taille	Emballage	\$	
NOIR	GALV.			NOIR	GALV.
35601	36601	1/8	150/1800	32.40	41.73
35602	36602	1/4	150/1800	32.40	41.73
35603	36603	3/8	150/1200	32.40	41.73
35604	36604	1/2	50/600	25.79	36.64
35605	36605	3/4	30/360	33.39	48.63
35606	36606	1	20/240	34.37	55.01
35607	36607	1 1/4	40/120	51.48	62.83
35608	36608	1 1/2	30/90	60.20	73.21
35609	36609	2	20/60	85.98	104.70
35610	36610	2 1/2	16/32	190.38	229.64
35611	36611	3	16/32	266.41	321.55
35612	36612	4	6/12	475.42	574.49
35613	-	5	1/10	1 361.43	-
35614	36614	6	1/10	1 558.93	2 122.88

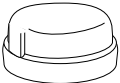

CAPUCHONS					
#BMI		Taille	Emballage	\$	
35501	36501	1/8	120/1440	29.00	38.95
35502	36502	1/4	80/960	26.63	32.55
35503	36503	3/8	60/720	26.63	32.55
35504	36504	1/2	75/300	24.05	29.40
35505	36505	3/4	40/160	29.28	35.47
35506	36506	1	25/100	41.15	50.13
35507	36507	1 1/4	20/80	60.20	73.21
35508	36508	1 1/2	18/54	78.80	96.22
35509	36509	2	12/36	109.61	133.55
35510	36510	2 1/2	20/40	247.50	298.87
35511	36511	3	12/24	342.41	413.65
35512	36512	4	6/12	570.49	689.32
35513	-	5	5/10	1 512.35	-
35514	36514	6	2/4	2 182.45	2 739.42

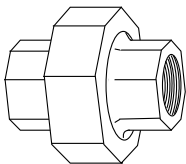

UNIONS (Bronze à acier)					
#BMI		Taille	Emballage	\$	
35101	36101	1/8	60/240	177.75	236.75
35102	36102	1/4	20/240	171.17	206.81
35103	36103	3/8	40/160	171.17	206.81
35104	36104	1/2	50/100	154.26	188.00
35105	36105	3/4	35/70	197.28	240.70
35106	36106	1	20/40	231.78	282.00
35107	36107	1 1/4	15/30	308.76	376.33
35108	36108	1 1/2	10/20	411.42	493.49
35109	36109	2	6/12	617.30	751.78
35110	36110	2 1/2	4/8	1 141.24	1 378.46
35111	36111	3	4/8	1 901.98	2 294.21
35112	36112	4	2/4	3 772.71	4 588.27

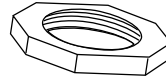

CONTRE-ÉCROUS HEXAGONAUX					
#BMI		Taille	Emballage	\$	
NOIR	GALV.			NOIR	GALV.
35695	36695	1/8	150/3000	31.18	39.26
35632	36632	1/4	125/1500	31.18	39.26
35633	36633	3/8	375/1500	31.18	39.26
35634	36634	1/2	50/600	31.18	29.95
35635	36635	3/4	90/360	24.83	29.95
35636	36636	1	60/240	30.68	36.94
35637	36637	1 1/4	45/180	39.89	48.38
35638	36638	1 1/2	45/135	51.22	75.33
35639	36639	2	25/75	79.88	96.47



BRIDES DE PLANCHER					
#BMI		Taille	Emballage	\$	
35703	-	3/8	1/75	98.86	-
35704	36704	1/2	25/50	98.86	119.52
35705	36705	3/4	15/45	137.05	165.59
35706	36706	1	15/30	159.96	192.95
35707	36707	1 1/4	10/30	228.07	275.64
35708	36708	1 1/2	8/24	266.41	321.55
35709	36709	2	8/16	323.24	390.64

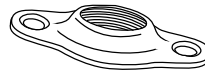

NOIX D'ANCRAGE					
#BMI		Taille	Emballage	\$	
-	36805	3/4	60/480	-	100.87

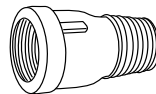

MANCHONS D'EXTENSION (MXF)					
#BMI		Taille	Emballage	\$	
35084	36084	1/2	75/300	57.10	80.65
-	36085	3/4	40/160	-	80.65



MANCHONS EN ACIER
 Pour ces items allez à la brochure:



La majorité des produits représentés dans ce document sont certifiés FM. Pour les détails et limites d'approbation, veuillez contacter votre représentant des ventes ou visiter <https://www.approvalguide.com>.



LISTE DE PRIX BMI CANADA - RACCORDS EN FONTE
MALLÉABLE EXTRALOUROUD - CLASSE #300

**MAX
25-1**

12 mars 2025

LISTE MAX 25-1

12 mars 2025

Cette liste de prix remplace MAX 22-2

3 pages



ISO 9001
ISO 14001



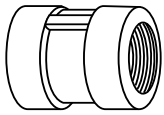

MANCHONS					
#BMI		Taille	Emballage	\$	
NOIR	GALV.			NOIR	GALV.
20002	-	1/4	200/400	67.28	-
20003	-	3/8	150/300	67.28	-
20004	20604	1/2	40/80	74.31	92.36
20005	20605	3/4	30/60	80.48	108.88
20006	20606	1	20/40	132.64	164.58
20007	20607	1 1/4	12/24	221.25	274.55
20008	20608	1 1/2	12/24	285.67	354.77
20009	20609	2	6/12	409.17	564.85
20010	-	2 1/2	4/8	808.04	-
20011	-	3	2/4	1 182.46	-

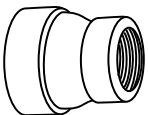

MANCHONS RÉDUITS					
3/8"					
20016	-	3/8 x 1/4	120/240	86.96	-
1/2"					
20019	-	1/2 x 3/8	100/200	106.66	-
20020	-	1/2 x 1/4	100/200	106.66	-
3/4"					
20023	20623	3/4 x 1/2	30/60	109.30	135.62
20024	-	3/4 x 3/8	60/120	109.30	-
1"					
20027	20627	1 x 3/4	20/40	132.64	164.58
20028	20628	1 x 1/2	25/50	132.64	164.58
1 1/4"					
20031	20631	1 1/4 x 1	20/40	204.68	230.92
20032	-	1 1/4 x 3/4	20/40	204.68	-
20033	-	1 1/4 x 1/2	20/40	204.68	-
1 1/2"					
20035	20635	1 1/2 x 1 1/4	18/36	252.04	303.63
20036	20636	1 1/2 x 1	18/36	252.04	303.63
20037	-	1 1/2 x 3/4	18/36	252.04	-
20038	-	1 1/2 x 1/2	18/36	252.04	-
2"					
20040	20640	2 x 1 1/2	8/16	409.17	462.00
20041	20641	2 x 1 1/4	8/16	409.17	462.00
20042	20642	2 x 1	12/24	409.17	462.00
2 1/2"					
20047	-	2 1/2 x 1 1/2	4/8	694.05	-
3"					
20052	-	3 x 2	4/8	1 218.00	-

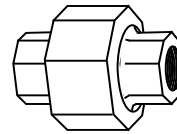

UNIONS					
#BMI		Taille	Emballage	\$	
NOIR	GALV.			NOIR	GALV.
20102	20122	1/4	120/240	199.24	238.09
20103	20123	3/8	90/180	191.27	228.59
20104	20124	1/2	40/80	187.25	223.73
20105	20125	3/4	30/60	240.87	288.23
20106	20126	1	18/36	281.43	337.02
20107	20127	1 1/4	12/24	376.24	458.04
20108	20128	1 1/2	10/20	502.36	604.51
20109	20129	2	6/12	749.28	899.30
20110	20130	2 1/2	4/8	1 284.88	1 523.73
20111	20131	3	3/6	2 131.98	2 547.51

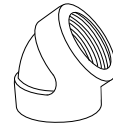

COUDES 45°					
20202	-	1/4	180/360	111.19	-
20203	-	3/8	120/240	111.19	-
20204	20224	1/2	40/80	123.68	153.37
20205	20225	3/4	30/60	132.03	170.21
20206	20226	1	20/40	160.83	188.96
20207	20227	1 1/4	12/24	243.60	302.39
20208	20228	1 1/2	8/16	329.90	393.58
20209	20229	2	6/12	511.46	654.95
20210	-	2 1/2	4/8	985.40	-
20211	-	3	2/4	1 433.21	-

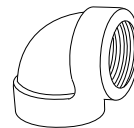

COUDES 90°					
20302	20322	1/4	180/360	87.76	92.36
20303	20323	3/8	120/240	80.48	82.36
20304	20324	1/2	40/80	75.59	105.72
20305	20325	3/4	30/60	89.17	121.15
20306	20326	1	20/40	142.53	186.93
20307	20327	1 1/4	12/24	204.68	278.05
20308	20328	1 1/2	8/16	292.25	373.59
20309	20329	2	6/12	438.43	589.37
20310	-	2 1/2	4/8	803.77	-
20311	-	3	2/4	1 379.50	-

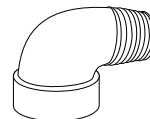

COUDES 90° (M x F)					
20372	-	1/4	180/360	94.95	-
20373	-	3/8	120/240	98.65	-
20374	-	1/2	40/80	114.82	-
20375	-	3/4	30/60	163.05	-
20376	-	1	20/40	191.73	-
20377	-	1 1/4	12/24	263.32	-
20378	-	1 1/2	8/16	344.01	-
20379	-	2	6/12	507.93	-

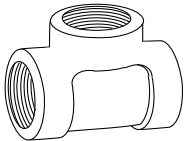

TÈS					
#BMI		Taille	Emballage	\$	
NOIR	GALV.			NOIR	GALV.
20402	-	1/4	120/240	105.93	-
20403	-	3/8	90/180	105.93	-
20404	20704	1/2	30/60	112.37	156.85
20405	20705	3/4	20/40	133.88	186.93
20406	20706	1	12/24	190.07	255.85
20407	20707	1 1/4	10/20	306.91	403.59
20408	20708	1 1/2	6/12	401.80	538.31
20409	20709	2	4/8	628.29	836.10
20410	-	2 1/2	2/4	1 254.11	-
20411	-	3	1/2	1 643.85	-

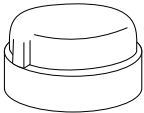

CAPUCHONS					
20504	20524	1/2	80/160	68.06	84.50
20505	20525	3/4	50/100	86.03	106.80
20506	20526	1	30/60	114.82	142.46
20507	20527	1 1/4	20/40	125.48	155.62
20508	20528	1 1/2	15/30	182.84	226.86
20509	20529	2	10/20	254.55	315.81
20510	-	2 1/2	8/16	482.21	-
20511	-	3	5/10	803.77	-



TÈS RÉDUITS					
#BMI		Taille	Emballage	\$	
NOIR	GALV.			NOIR	GALV.
3/4"					
20429	20729	3/4 x 3/4 x 1/2	30/60	201.65	250.21
1"					
20438	20738	1 x 1 x 3/4	15/30	246.48	305.81
20440	20740	1 x 1 x 1/2	16/32	246.48	305.81
1 1/4"					
20453	-	1 1/4 x 1 1/4 x 1	12/24	340.36	-
20454	-	1 1/4 x 1 1/4 x 3/4	12/24	340.36	-
20455	-	1 1/4 x 1 1/4 x 1/2	24/24	340.36	-
1 1/2"					
20471	-	1 1/2 x 1 1/2 x 1 1/4	8/16	438.96	-
20472	20772	1 1/2 x 1 1/2 x 1	10/20	438.96	544.93
20473	20773	1 1/2 x 1 1/2 x 3/4	8/16	438.96	544.93
20474	-	1 1/2 x 1 1/2 x 1/2	8/16	438.96	-
2"					
20494	20794	2 x 2 x 1 1/2	5/10	659.29	818.37
20495	-	2 x 2 x 1 1/4	5/10	659.29	-
20496	-	2 x 2 x 1	10/10	659.29	-
20497	-	2 x 2 x 3/4	12/12	659.29	-
20498	-	2 x 2 x 1/2	5/10	659.29	-

La majorité des produits représentés dans ce document sont certifiés FM. Pour les détails et limites d'approbation, veuillez contacter votre représentant des ventes ou visiter <https://www.approvalguide.com>.

LISTE DE PRIX BMI CANADA - BRIDES
COMPAGNON EN FONTE

**CFL
25-1**

12 mars 2025

BRIDES COMPAGNON EN FONTE GRISE

NOIRES		GALVANISÉES		TAILLE RÉGULIÈRE
#BMI	\$	#BMI	\$	
16606	97.12			1 x 4 1/4
16607	108.88	16807	120.93	1 1/4 x 4 5/8
-	-	16808	140.87	1 1/2 x 5
-	-	16809	234.85	2 x 6
16612	397.13	16812	699.29	4 x 9
16614	678.24	16814	1 015.33	6 x 11
16616	1 049.88			8 x 13 1/2

NOIRES		TAILLE RÉDUITE
#BMI	\$	
16656	353.32	1 1/2 x 7 1/2
16659	272.59	2 x 7
16662	1 049.88	2 x 11
16664	323.04	2 1/2 x 7 1/2
16665	545.09	2 1/2 x 9
16666	1 009.49	2 1/2 x 11
16672	848.01	4 x 11
16673	1 494.05	4 x 13 1/2

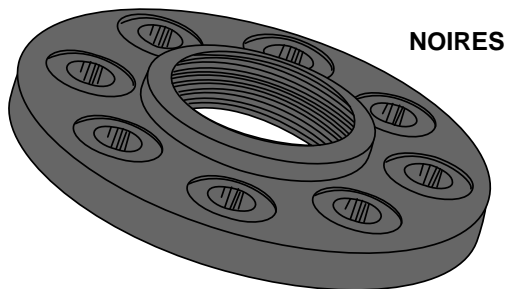

NOIRES

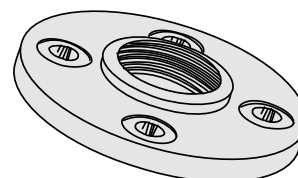

GALVANISÉES

Classe 125 (standard) : celles-ci sont fabriquées selon les normes standards "d'American National" ANSI B16.1, matériaux en acier malléable ASTM A197, dimensions selon les spécifications fédérales WW-F-406.

BRIDES PLEINES EN FONTE GRISE

NOIRES		TAILLE RÉGULIÈRE
#BMI	\$	
16708	201.03	1 1/2 x 5
16709	221.92	2 x 6
16710	319.54	2 1/2 x 7
16712	707.11	4 x 9
16714	1 104.75	6 x 11

GALVANISÉES \$	RÉGULIÈRE
16908	277.69 1 1/2 x 5

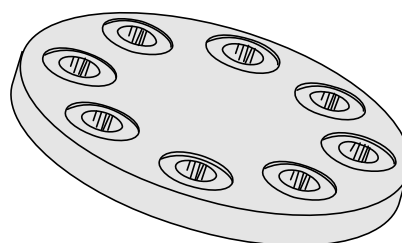

GALVANISÉES

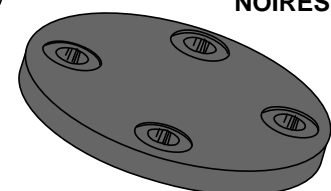

NOIRES

Lorsque vous commandez nos brides, toujours donner le diamètre extérieur ainsi que la grandeur nominale du tuyau.

BRIDES COMPAGNON EN FONTE DUCTILE

NOIRES		GALVANISÉES		TAILLE RÉGULIÈRE
#BMI	\$	#BMI	\$	
16106	97.12			1 x 4 1/4
16107	108.88	16307	120.93	1 1/4 x 4 5/8
16108	121.05	16308	140.86	1 1/2 x 5
16109	144.09	16309	234.84	2 x 6
16110	218.29	16310	368.10	2 1/2 x 7
16111	260.19	16311	458.15	3 x 7 1/2
16112	397.13	16312	699.28	4 x 9
16114	678.24	16314	1 015.32	6 x 11
16116	1 049.88			8 x 13 1/2

NOIRES		TAILLE RÉDUITE
#BMI	\$	
16156	353.32	1 1/2 x 7 1/2
16159	272.59	2 x 7
16160	343.22	2 x 7 1/2
16161	565.29	2 x 9
16162	1 049.88	2 x 11
16164	323.03	2 1/2 x 7 1/2
16165	545.08	2 1/2 x 9
16166	1 009.49	2 1/2 x 11
16167	514.81	3 x 9
16169	928.76	3 x 11
16172	848.01	4 x 11
16173	1 494.05	4 x 13 1/2

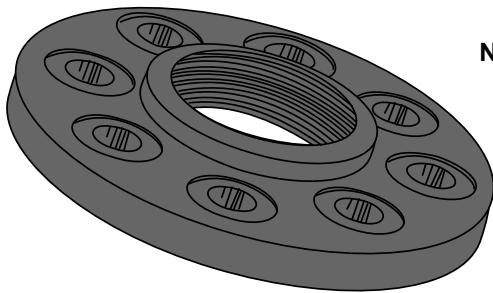

NOIRES

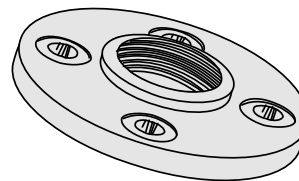

GALVANISÉES

Classe 150 : celles-ci sont fabriquées selon les normes ASME B16.42/AWWA C110, matériaux en fonte ductile ASTM A536, grade 65-45-12. Plus de renseignements sont disponibles sur la fiche technique de BMI.

BRIDES PLEINES EN FONTE DUCTILE

NOIRES		TAILLE RÉGULIÈRE
#BMI	\$	
16208	201.03	1 1/2 x 5
16209	221.92	2 x 6
16210	319.54	2 1/2 x 7
16211	397.71	3 x 7 1/2
16212	707.10	4 x 9
16214	1 104.75	6 x 11

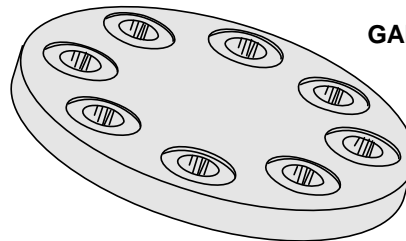

GALVANISÉES

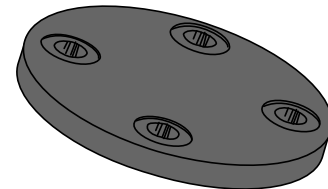

NOIRES

Lorsque vous commandez nos brides, toujours donner le diamètre extérieur ainsi que la grandeur nominale du tuyau.



LISTE DE PRIX BMI CANADA RACCORDS EN
POLY-ALLIAGE (PPSU) EXPANSION À FROID - F1960



**CXP
25-1**

12 mars 2025



MANCHONS				
#BMI	Taille	Emballage	Code à barres	\$
42004	1/2	25/400	777701420047	7.26
42005	3/4	25/200	777701420054	11.09
42006	1	10/100	777701420061	17.11
42007	1 1/4	5/50	777701420078	56.38
42008	1 1/2	5/25	777701420085	76.74
42009	2	1/20	777701420092	179.56
42023	3/4 x 1/2	25/250	777701420238	8.96
42027	1 x 3/4	25/300	777701420276	14.82
42031	1 1/4 x 1	5/50	777701420313	50.26
42032	1 1/4 x 3/4	5/50	777701420320	53.11
42035	1 1/2 x 1 1/4	5/25	777701420351	73.38
42036	1 1/2 x 1	5/25	777701420368	62.74
42037	1 1/2 x 3/4	5/25	777701420375	60.93
42040	2 x 1 1/2	5/20	777701420405	139.08



TÉS				
#BMI	Taille	Emballage	Code à barres	\$
42404	1/2	25/200	777701424045	11.96
42405	3/4	10/100	777701424052	20.94
42406	1	10/100	777701424069	34.59
42407	1 1/4	5/50	777701424076	116.91
42408	1 1/2	1/25	777701424083	182.66
42409	2	1/10	777701424090	380.51
42420	1/2 x 1/2 x 3/4	10/200	777701424205	17.11
42428	3/4 x 3/4 x 1	10/100	777701424281	27.69
42429	3/4 x 3/4 x 1/2	10/100	777701424298	17.94
42430	3/4 x 1/2 x 3/4	10/100	777701424304	20.50
42431	3/4 x 1/2 x 1/2	10/120	777701424311	15.03
42443	1 x 3/4 x 3/4	10/100	777701424434	25.75
42440	1 x 1 x 1/2	10/150	777701424403	29.94
42438	1 x 1 x 3/4	5/50	777701424380	34.94
42453	1 1/4 x 1 1/4 x 1	5/50	777701424533	100.28



BOUCHONS				
#BMI	Taille	Emballage	Code à barres	\$
42604	1/2	50/800	777701426049	4.27
42605	3/4	25/400	777701426056	8.12
42606	1	10/150	777701426063	12.72
42607	1 1/4	5/50	777701426070	41.23
42608	1 1/2	5/50	777701426087	54.94
42609	2	5/25	777701426094	118.75

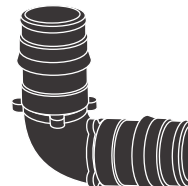

COUDES 90°				
#BMI	Taille	Emballage	Code à barres	\$
42304	1/2	25/250	777701423048	9.41
42305	3/4	10/120	777701423055	15.38
42306	1	10/150	777701423062	34.17
42307	1 1/4	5/50	777701423079	98.74
42308	1 1/2	1/25	777701423086	129.71
42309	2	1/10	777701423093	288.61
42323	3/4 x 1/2	25/400	777701423239	12.31



Quantité minimale de commande « Inner »

ANNEAUX F1960 EXPANSION À FROID				
#BMI	Taille	Emballage	Code à barres	\$
42104	1/2	100/1300	777701421044	2.34
42105	3/4	50/600	777701421051	3.45
42106	1	30/300	777701421068	6.89
42107	1 1/4	10/200	777701421075	14.68

Laiton forgé

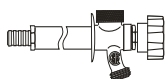

ROBINETS ANTIGEL

Voir liste :

FFF



VALVES À BILLE

BRV

Chromé

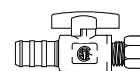

VALVES CHROMÉES

Voir liste :

CPV

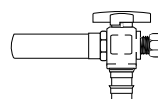

ANTIBÉLIERS

WHALS



COLLECTEURS À 3 SORTIES				
#BMI	Taille	Emballage	Code à barres	\$
42501	3/4 x 1/2	10/50	777701425011	76.53



COLLECTEURS COMMERCIAUX À 3 SORTIES				
#BMI	Taille	Emballage	Code à barres	\$
42511	1 1/4 x 3/4	1/25	777701425110	240.43



COLLECTEURS À 4 SORTIES				
#BMI	Taille	Emballage	Code à barres	\$
42502	3/4 x 1/2	10/50	777701425028	92.10
42503	1 x 1/2	10/50	777701425035	127.44



COLLECTEURS À 6 SORTIES				
#BMI	Taille	Emballage	Code à barres	\$
42504	3/4 x 1/2	5/25	777701425042	123.26
42505	1 x 1/2	5/25	777701425059	189.63

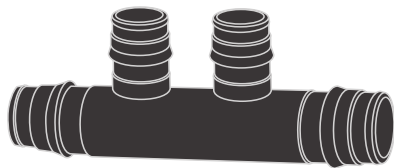

COLLECTEURS OUVERTS À 2 SORTIES				
#BMI	Taille	Emballage	Code à barres	\$
42523	3/4 x 1/2	10/100	777701425233	60.22



COLLECTEURS OUVERTS À 3 SORTIES				
#BMI	Taille	Emballage	Code à barres	\$
42524	3/4 x 1/2	10/50	777701425240	77.21
42521	1 1/4 x 3/4	1/25	777701425219	215.90
42522	2 x 1	1/25	777701425226	459.61



COLLECTEURS OUVERTS À 3 SORTIES				
#BMI	Taille	Emballage	Code à barres	\$
42525	1 x 3/4 x 1/2	10/50	777701425257	102.69

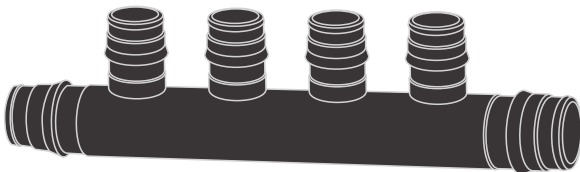

COLLECTEURS OUVERTS À 4 SORTIES				
#BMI	Taille	Emballage	Code à barres	\$
42526	3/4 x 1/2	10/50	777701425264	92.86
42528	1 x 1/2	10/50	777701425288	126.00

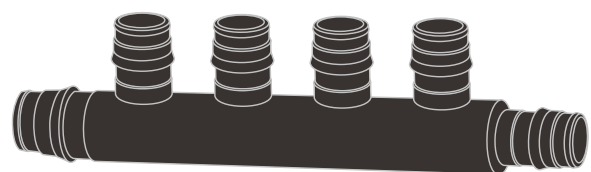

COLLECTEURS OUVERTS À 4 SORTIES				
#BMI	Taille	Emballage	Code à barres	\$
42527	1 x 3/4 x 1/2	10/50	777701425271	124.63

RACCORDS EN POLY-ALLIAGE (PPSU) EXPANSION À FROID - F1960



COLLECTEURS OUVERTS À 6 SORTIES				
#BMI	Taille	Emballage	Code à barres	\$
42529	3/4 x 1/2	5/25	777701425295	128.13
42531	1 x 1/2	5/25	777701425318	172.71



COLLECTEURS OUVERTS À 6 SORTIES				
#BMI	Taille	Emballage	Code à barres	\$
42530	1 x 3/4 x 1/2	5/25	777701425301	168.45

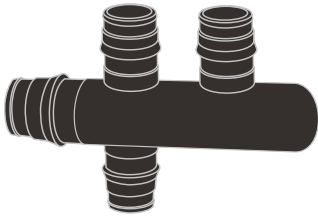

COLLECTEURS À OUVERTURES OPPOSÉES À 3 SORTIES				
42541	3/4 x 1/2	10/50	777701425417	56.72

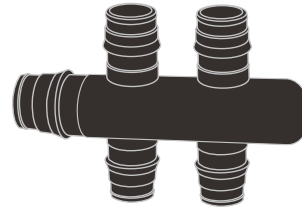

COLLECTEURS À OUVERTURES OPPOSÉES À 4 SORTIES				
42542	3/4 x 1/2	10/50	777701425424	59.53

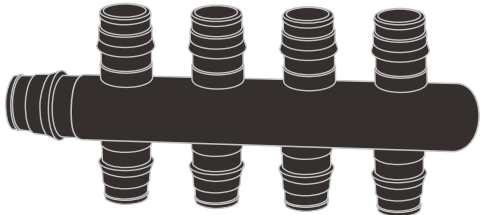

COLLECTEURS À OUVERTURES OPPOSÉES À 8 SORTIES				
42543	3/4 x 1/2	5/25	777701425431	101.33

RACCORDS EN POLY-ALLIAGE (PPSU) EXPANSION À FROID - F1960

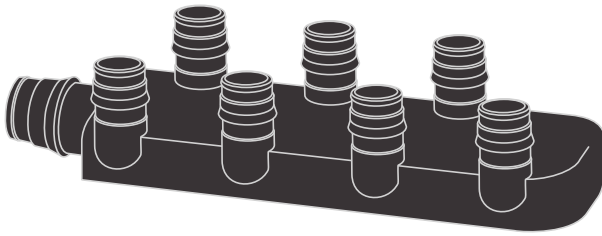

COLLECTEURS COMMERCIAUX À 7 SORTIES				
#BMI	Taille	Emballage	Code à barres	\$
42512	3/4 x 1/2	1/50	777701425127	143.88
42514	1 x 1/2	1/1	777701425141	245.71

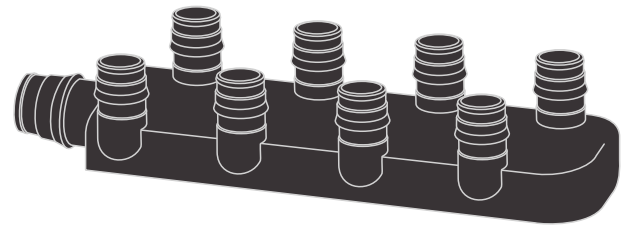

COLLECTEURS COMMERCIAUX À 8 SORTIES				
#BMI	Taille	Emballage	Code à barres	\$
42513	3/4 x 1/2	1/50	777701425134	175.81
42515	1 x 1/2	1/50	777701425158	280.44

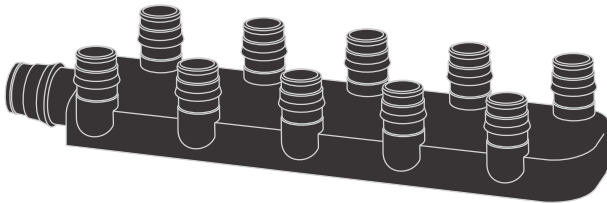

COLLECTEURS COMMERCIAUX À 10 SORTIES				
#BMI	Taille	Emballage	Code à barres	\$
42516	1 x 1/2	1/50	777701425165	354.69

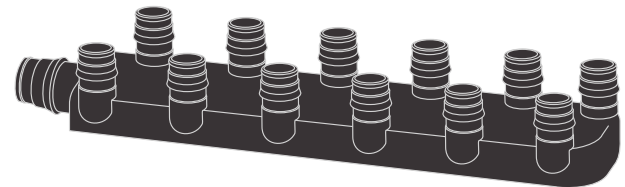

COLLECTEURS COMMERCIAUX À 12 SORTIES				
#BMI	Taille	Emballage	Code à barres	\$
42517	1 x 1/2	1/50	777701425172	419.36



LISTE DE PRIX BMI CANADA RACCORDS EN LAITON EXPANSION À FROID - F1960



**CXB
26-1**

9 mars 2026

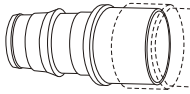

ADAPTATEURS EN LAITON EXP x RACC.				
#BMI	Taille	Emballage	Code à barres	\$
44914	1/2	25/750	777701449147	12.56
44915	3/4	25/400	777701449154	24.38
44916	1	25/200	777701449161	41.57
44927	1/2 x 3/4	25/400	777701449277	16.71

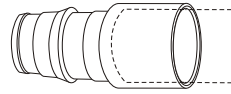

ADAPTATEURS EN LAITON EXP x COP				
#BMI	Taille	Emballage	Code à barres	\$
44904	1/2	50/750	777701449048	10.60
44905	3/4	25/400	777701449055	20.78
44906	1	25/200	777701449062	43.13

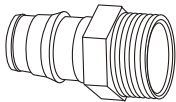

ADAPTATEURS EN LAITON EXP x MIPS				
#BMI	Taille	Emballage	Code à barres	\$
44804	1/2	25/400	777701448041	15.09
44805	3/4	25/300	777701448058	22.79
44806	1	25/150	777701448065	51.05
44807	1 1/4	10/80	777701448072	94.23
44808	1 1/2	5/60	777701448089	125.42
44809	2	1/25	777701448096	230.91
44817	1/2 x 3/4	25/250	777701448171	21.78
44823	3/4 x 1/2	25/300	777701448232	25.16

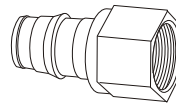

ADAPTATEURS EN LAITON EXP x FIPS				
#BMI	Taille	Emballage	Code à barres	\$
44704	1/2	25/400	777701447044	15.97
44705	3/4	25/250	777701447051	25.19
44706	1	25/150	777701447068	54.87
44707	1 1/4	10/80	777701447075	99.60
44708	1 1/2	5/60	777701447082	128.74
44709	2	5/40	777701447099	239.29
44717	1/2 x 3/4	25/250	777701447174	22.95
44723	3/4 x 1/2	25/250	777701447235	20.77

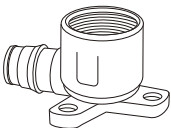

COUDE 90° EXP x FIPS avec OREILLES				
#BMI	Taille	Emballage	Code à barres	\$
44399	1/2	25/200	777701443992	36.11
44375	3/4	25/100	777701443756	48.62
44378	3/4 x 1/2	25/150	777701443787	50.82

LISTE DE PRIX BMI CANADA PEX POLY-ALLIAGE
(PLASTIQUE)



**PPX
25-1**

12 mars 2025



MANCHONS				
#BMI	Taille	Emballage	Code à barres	\$
30904	1/2	50/1000	777701309045	2.46
30905	3/4	50/500	777701309052	4.06
30006	1	25/200	777701300066	7.69
30023	3/4 x 1/2	50/600	777701300233	3.24
30027	1 x 3/4	25/300	777701300271	6.99



COUDES 90°				
#BMI	Taille	Emballage	Code à barres	\$
30914	1/2	50/600	777701309144	3.53
30915	3/4	25/300	777701309151	6.97
30306	1	10/150	777701303067	15.52



COUDES 90° PEX x MIPS				
#BMI	Taille	Emballage	Code à barres	\$
30364	1/2	25/500	777701303647	7.66
30365	3/4	25/350	777701303654	11.58



ADAPTATEURS PEX x LAVABO				
#BMI	Taille	Emballage	Code à barres	\$
30204	1/2 x 1/2 FIPS	50/400	777701302046	7.47
30206	3/4 x 3/4 FIPS	25/200	777701302060	12.93



TÉS				
#BMI	Taille	Emballage	Code à barres	\$
30924	1/2	50/400	777701309243	4.76
30925	3/4	25/200	777701309250	9.78
30406	1	10/100	777701304064	19.93
30420	1/2 x 1/2 x 3/4	25/300	777701304200	6.33
30929	3/4 x 3/4 x 1/2	25/250	777701309298	7.87
30930	3/4 x 1/2 x 3/4	25/250	777701309304	7.87
30931	3/4 x 1/2 x 1/2	25/300	777701309311	6.33
30438	1 x 1 x 3/4	10/100	777701304385	15.52
30440	1 x 1 x 1/2	10/150	777701304408	14.73
30442	1 x 3/4 x 1	10/100	777701304422	19.09
30443	1 x 3/4 x 3/4	10/100	777701304439	16.22



BOUCHONS				
#BMI	Taille	Emballage	Code à barres	\$
30934	1/2	100/2000	777701309342	2.21
30935	3/4	100/1000	777701309359	3.61
30606	1	50/500	777701306068	5.67



ADAPTATEURS PEX x MIPS				
#BMI	Taille	Emballage	Code à barres	\$
30804	1/2	50/500	777701308048	6.04
30805	3/4	25/350	777701308055	7.72
30806	1	10/160	777701308062	14.85
30817	1/2 x 3/4	25/350	777701308178	6.99
30823	3/4 x 1/2	50/400	777701308239	6.99

**Laiton
forgé**

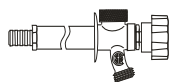

ROBINETS ANTIGEL FFF



VALVES À BILLE BRV

Voir liste :

Chromé

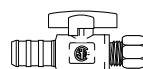

VALVES CHROMÉES CPV

Voir liste :

LISTE DE PRIX BMI CANADA RACCORDS PEX SANS PLOMB



PEX 26-1

9 mars 2026

MANCHONS				
#BMI	Taille	Emballage	Code à barres	\$
39004	1/2	50/1000	777701390043	5.06
39005	3/4	25/500	777701390050	8.10
39006	1	25/300	777701390067	14.16
39007	1 1/4	1/50	777701390074	29.92
39008	1 1/2	1/30	777701390081	89.53
39009	2	1/20	777701390098	104.75
39023	3/4 x 1/2	50/500	777701390234	8.02
39027	1 x 3/4	50/400	777701390272	12.58



Quantité minimale de commande « Inner »

ANNEAUX DE COMPRESSION (CUIVRE)				
#BMI	Taille	Emballage	Code à barres	\$
39104	1/2	100/1000	777701391040	2.12
39105	3/4	50/500	777701391057	2.92
39106	1	50/500	777701391064	3.83



Quantité minimale de commande « Inner »

ANNEAUX DE COMPRESSION (ACIER INOXYDABLE)				
#BMI	Taille	Emballage	Code à barres	\$
39124	1/2	100/2000	777701391248	3.65
39125	3/4	50/2000	777701391255	5.55
39126	1	50/1000	777701391262	7.44

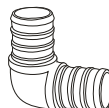

COUDES 90°				
#BMI	Taille	Emballage	Code à barres	\$
39304	1/2	50/750	777701393044	6.68
39305	3/4	25/200	777701393051	11.35
39306	1	25/150	777701393068	21.42
39307	1 1/4	1/25	777701393075	55.43
39308	1 1/2	1/20	777701393082	85.68
39309	2	1/10	777701393099	154.39
39323	3/4 x 1/2	25/200	777701393235	11.79

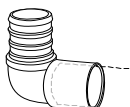

COUDES PEX x COP 90°				
#BMI	Taille	Emballage	Code à barres	\$
39344	1/2	25/500	777701393440	11.17
39345	3/4	25/200	777701393457	21.45
39348	1/2 x 3/4	25/200	777701393488	20.64

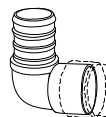

COUDES PEX x RACC. 90°				
#BMI	Taille	Emballage	Code à barres	\$
39354	1/2	25/500	777701393549	11.17
39355	3/4	25/200	777701393556	23.22

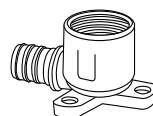

COUDE 90° PEX x FIPS avec OREILLES				
#BMI	Taille	Emballage	Code à barres	\$
39399	1/2	25/200	777701393990	26.11
39375	3/4	25/100	777701393754	42.81
39378	3/4 x 1/2	25/150	777701393785	34.18

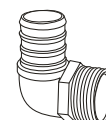

1/2" COUDE 90° PEX x MIPS				
#BMI	Taille	Emballage	Code à barres	\$
39364	1/2	25/300	777701393648	19.90
39365	3/4	25/200	777701393655	33.02

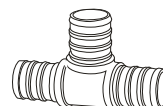

TÉS				
#BMI	Taille	Emballage	Code à barres	\$
39404	1/2	50/500	777701394041	9.87
39405	3/4	25/250	777701394058	15.43
39406	1	25/150	777701394065	25.70
39407	1 1/4	1/20	777701394072	65.39
39408	1 1/2	1/10	777701394089	98.65
39409	2	1/6	777701394096	169.86
39420	1/2 x 1/2 x 3/4	25/250	777701394201	16.48
39428	3/4 x 3/4 x 1	25/200	777701394287	33.59
39429	3/4 x 3/4 x 1/2	25/250	777701394294	13.10
39430	3/4 x 1/2 x 3/4	25/250	777701394300	16.70
39431	3/4 x 1/2 x 1/2	25/250	777701394317	14.33
39438	1 x 1 x 3/4	25/200	777701394386	29.08
39440	1 x 1 x 1/2	25/200	777701394409	24.21
39442	1 x 3/4 x 1	25/200	777701394423	27.91
39443	1 x 3/4 x 3/4	25/200	777701394430	29.69
39445	1 x 3/4 x 1/2	25/200	777701394454	23.07
39448	1 x 1/2 x 1	25/200	777701394485	29.45

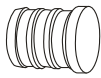

BOUCHONS				
#BMI	Taille	Emballage	Code à barres	\$
39604	1/2	100/2000	777701396045	3.85
39605	3/4	50/1000	777701396052	6.04
39606	1	50/500	777701396069	10.80

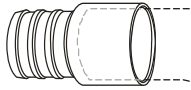

ADAPTATEURS PEX x CUIVRE (pour tuyaux)				
#BMI	Taille	Emballage	Code à barres	\$
39904	1/2	50/750	777701399046	7.36
39905	3/4	25/400	777701399053	11.16
39906	1	25/200	777701399060	21.42
39923	3/4 x 1/2	25/400	777701399237	12.94

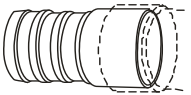

ADAPTATEURS PEX x CUIVRE (dans le raccord)				
#BMI	Taille	Emballage	Code à barres	\$
39914	1/2	50/1000	777701399145	5.50
39915	3/4	25/400	777701399152	10.52
39916	1	25/200	777701399169	18.00
39917	3/4 x 1/2	25/400	777701399176	14.86

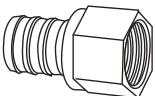

ADAPTATEURS PEX x FIPS				
#BMI	Taille	Emballage	Code à barres	\$
39704	1/2	25/400	777701397042	13.96
39705	3/4	25/250	777701397059	19.78
39706	1	25/150	777701397066	31.74
39707	1 1/4	1/40	777701397073	67.33
39708	1 1/2	1/30	777701397080	84.16
39709	2	1/15	777701397097	133.52
39717	1/2 x 3/4	25/250	777701397172	20.03
39723	3/4 x 1/2	25/250	777701397233	17.50

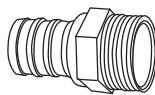

ADAPTATEURS PEX x MIPS				
#BMI	Taille	Emballage	Code à barres	\$
39804	1/2	25/400	777701398049	12.40
39805	3/4	25/300	777701398056	17.28
39806	1	25/150	777701398063	31.83
39807	1 1/4	1/40	777701398070	62.26
39808	1 1/2	1/30	777701398087	79.79
39809	2	1/20	777701398094	130.04
39817	1/2 x 3/4	25/250	777701398179	17.28
39823	3/4 x 1/2	25/300	777701398230	12.68
39827	3/4 x 1	25/150	777701398278	30.25
39833	1 x 3/4	25/150	777701398339	20.37

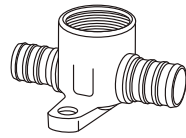

TÉS PEX x FIPS avec OREILLES				
#BMI	Taille	Emballage	Code à barres	\$
39499	1/2	1/150	777701394997	41.09
39475	3/4	10/100	777701394751	59.78

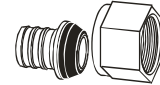

ADAPTATEURS PEX x LAVABO (tout laiton)				
#BMI	Taille	Emballage	Code à barres	\$
39204	1/2 x 1/2 FIPS	25/400	777701392047	17.74
39207	1/2 x 3/4 FIPS	10/150	777701392078	29.74

ADAPTATEURS PEX x LAVABO (plastique)				
#BMI	Taille	Emballage	Code à barres	\$
39214	1/2 x 1/2	25/400	777701392146	18.39

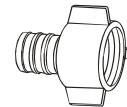

ADAPTATEURS PEX x BC				
#BMI	Taille	Emballage	Code à barres	\$
39206	3/4 x 3/4 FIPS	10/150	777701392061	39.84



COUDES CHAMBRE				
#BMI	Taille	Emballage	Code à barres	\$
39501	3/8 PEX 3 1/2 x 6	1/1	777701395017	32.84
39502	1/2 PEX 3 1/2 x 6	10/300	777701395024	35.28
39503	1/2 PEX 3 1/2 x 8	10/50	777701395031	43.63
39504	1/2 PEX 3 1/2 x 12	10/50	777701395048	43.55

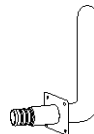

COUDES CHAMBRE AVEC BRIDE				
#BMI	Taille	Emballage	Code à barres	\$
39506	1/2 PEX 3 1/2 x 6	1/30	777701395062	43.38
39507	1/2 PEX 3 1/2 x 8	10/30	777701395079	56.98
39510	3/4 PEX 4 x 8	10/150	777701395109	74.34

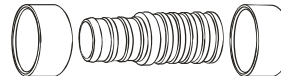

ADAPTATEURS PEX x PB				
#BMI	Taille	Emballage	Code à barres	\$
39924	1/2	50/1000	777701399244	10.50
39925	3/4	25/500	777701399251	14.78

RACCORDS PEX SANS PLOMB



OUTILS DE SERTISSAGE 3 POIGNES BAGUE INOX.				
#BMI	Taille	Emballage	Code à barres	\$
39121	1/2, 3/4 & 1	1/20	777701391217	1 649.50



OUTILS COMBO COMPRESSION BAGUE DE CUIVRE				
#BMI	Taille	Emballage	Code à barres	\$
39100	1/2 & 3/4	1/5	777701391002	1 211.11



OUTILS DE COUPE TUYAU PEX				
#BMI	Taille	Emballage	Code à barres	\$
39001	1/2 ~ 1	1/25	777701390012	115.82



OUTILS MULTI COMPRESSION BAGUE DE CUIVRE				
#BMI	Taille	Emballage	Code à barres	\$
39101	3/8 ~ 1	1/5	777701391019	1 384.76

Autres produits complémentaires au PEX

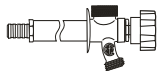

ROBINETS ANTIGEL

Voir liste :

FFF

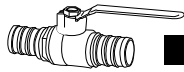

VALVES À BILLE

BBV



VALVES CHROMÉES

CPV

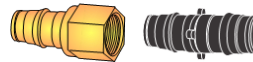

EXP. À FROID F1960

Voir liste :

CXP



PEX POLY-ALLIAGE

PPX

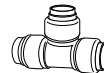

'PUSH-FIT'

PFT



**LISTE DE PRIX BMI CANADA
RACCORDS 'PUSH-FIT' SANS PLOMB**



**PFT
26-1**

9 mars 2026

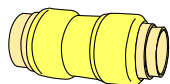

MANCHONS 'PUSH-FIT'				
#BMI	Taille	Emballage	Code-barres	\$
38004	1/2	10/200	777701380044	25.00
38005	3/4	5/100	777701380051	39.75
38006	1	2/60	777701380068	65.97
38007	1 1/4	1/10	777701380075	222.03
38008	1 1/2	1/6	777701380082	329.30
38009	2	1/4	777701380099	477.95
38023	3/4 x 1/2	5/120	777701380235	33.61
38027	1 x 3/4	2/80	777701380273	63.52
38031	1 1/4 x 1	1/10	777701380310	141.11
38035	1 1/2 x 1 1/4	1/6	777701380358	263.42
38040	2 x 1 1/2	1/5	777701380402	423.38

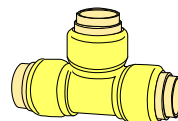

TÉS 'PUSH-FIT'				
#BMI	Taille	Emballage	Code-barres	\$
38404	1/2	10/120	777701384042	45.26
38405	3/4	5/60	777701384059	78.25
38406	1	2/30	777701384066	139.28
38407	1 1/4	1/6	777701384073	406.91
38408	1 1/2	1/3	777701384080	699.06
38409	2	1/2	777701384097	972.82
38419	1/2 x 1/2 x 1	2/40	777701384196	75.31
38420	1/2 x 1/2 x 3/4	5/60	777701384202	58.81
38429	3/4 x 3/4 x 1/2	5/60	777701384295	72.99
38430	3/4 x 1/2 x 3/4	5/60	777701384301	67.87
38431	3/4 x 1/2 x 1/2	5/60	777701384318	64.14
38438	1 x 1 x 3/4	2/30	777701384387	116.42

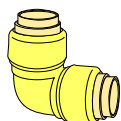

COUDES 90° 'PUSH-FIT'				
#BMI	Taille	Emballage	Code-barres	\$
38304	1/2	10/150	777701383045	33.02
38305	3/4	5/100	777701383052	53.46
38306	1	2/60	777701383069	96.67
38307	1 1/4	1/8	777701383076	313.79
38308	1 1/2	1/5	777701383083	457.24
38309	2	1/3	777701383090	759.73
38323	3/4 x 1/2	5/100	777701383236	43.76

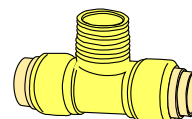

TÉS 'PUSH-FIT' x MIPS				
#BMI	Taille	Emballage	Code-barres	\$
38574	1/2	10/120	777701385742	41.84
38575	3/4	5/60	777701385759	76.12

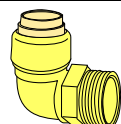

COUDES 90° 'PUSH-FIT' x MIPS				
#BMI	Taille	Emballage	Code-barres	\$
38364	1/2	10/150	777701383649	34.12
38365	3/4	5/100	777701383656	56.85
38366	1	2/50	777701383663	90.97

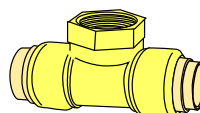

TÉS 'PUSH-FIT' x FIPS				
#BMI	Taille	Emballage	Code-barres	\$
38591	1/2	10/100	777701385919	44.20
38592	3/4	5/50	777701385926	76.61

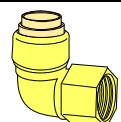

COUDE 90° 'PUSH-FIT' x FIPS AVEC OREILLES				
#BMI	Taille	Emballage	Code-barres	\$
38399	1/2	10/100	777701383991	45.12

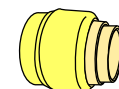

COUDE 90° 'PUSH-FIT' x FIPS				
#BMI	Taille	Emballage	Code-barres	\$
38384	1/2	10/150	777701383847	35.25
38385	3/4	5/100	777701383854	55.71
38386	1	2/50	777701383861	86.42

CAPUCHONS 'PUSH-FIT'				
#BMI	Taille	Emballage	Code-barres	\$
38504	1/2	10/300	777701385049	17.66
38505	3/4	5/200	777701385056	24.52
38506	1	2/140	777701385063	45.52
38507	1 1/4	1/20	777701385070	118.18
38508	1 1/2	1/12	777701385087	186.58
38509	2	1/8	777701385094	299.64

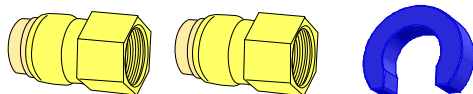

ENSEMBLE 'PUSH-FIT' x FIPS POUR CHAUFFE-EAU				
#BMI	Taille	Emballage	Code-barres	\$
38724	1/2 x 3/4	1/1	777701387241	85.59
38725	3/4 x 3/4	2/2	777701387258	86.46

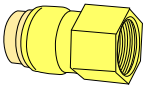

ADAPTATEURS 'PUSH-FIT' x FIPS				
#BMI	Taille	Emballage	Code-barres	\$
38704	1/2	10/200	777701387043	27.07
38705	3/4	5/80	777701387050	42.08
38706	1	2/60	777701387067	61.87
38707	1 1/4	1/10	777701387074	176.71
38708	1 1/2	1/8	777701387081	237.93
38709	2	1/6	777701387098	350.29
38717	1/2 x 3/4	5/180	777701387173	30.65

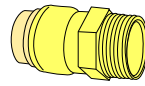

ADAPTATEURS 'PUSH-FIT' x MIPS				
#BMI	Taille	Emballage	Code-barres	\$
38804	1/2	10/150	777701388040	22.53
38805	3/4	5/100	777701388057	30.55
38806	1	2/64	777701388064	56.30
38807	1 1/4	2/10	777701388071	176.71
38808	1 1/2	1/8	777701388088	237.93
38809	2	1/6	777701388095	350.29
38817	1/2 x 3/4	5/180	777701388170	32.04

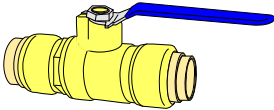

VALVES À BILLE 'PUSH-FIT'				
#BMI	Taille	Emballage	Code-barres	\$
38604	1/2	10/80	777701386046	79.22
38605	3/4	5/45	777701386053	109.31
38606	1	2/30	777701386060	215.88



OUTILS DE DÉSACOUPLEMENT				
#BMI	Taille	Emballage	Code-barres	\$
38104	1/2	50/900	777701381041	1.72
38105	3/4	25/500	777701381058	2.78
38106	1	10/400	777701381065	3.54
38107	1 1/4	1/80	777701381072	69.14
38108	1 1/2	1/48	777701381089	103.96
38109	2	1/30	777701381096	138.78

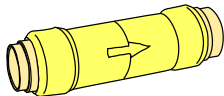

VALVES DE RETENUE 'PUSH-FIT'				
#BMI	Taille	Emballage	Code-barres	\$
38654	1/2	10/50	777701386541	43.10
38655	3/4	5/30	777701386558	88.88
38656	1	2/30	777701386565	135.08

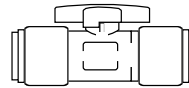

VALVES À BILLE DROITE 'PUSH-FIT' CHROME				
#BMI	Taille	Emballage	Code-barres	\$
38904	1/2 x 1/2	10/100	777701389047	70.94

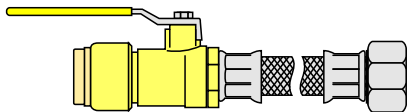

VALVES À BILLE 'PUSH-FIT' x FIPS AVEC TUBE				
#BMI	Taille	Emballage	Code-barres	\$
38612	3/4 x 12"	5/25	777701386121	173.70
38615	3/4 x 15"	5/25	777701386152	181.80
38618	3/4 x 18"	5/25	777701386183	185.27
38624	3/4 x 24"	5/25	777701386244	192.23
38632	1/2 x 3/4 x 12"	5/25	777701386329	143.61
38635	1/2 x 3/4 x 15"	5/25	777701386350	149.39
38638	1/2 x 3/4 x 18"	5/25	777701386381	152.85
38644	1/2 x 3/4 x 24"	5/25	777701386442	166.75

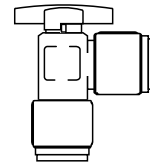

VALVES À BILLE ANGLE 'PUSH-FIT' CHROME				
#BMI	Taille	Emballage	Code-barres	\$
38909	1/2 x 1/2	10/100	777701389092	71.86

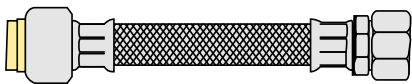

TUBE FLEXIBLE 'PUSH-FIT' x FIPS				
#BMI	Taille	Emballage	Code-barres	\$
38212	3/4 x 12"	5/25	777701382123	102.35
38215	3/4 x 15"	5/25	777701382154	109.14
38218	3/4 x 18"	5/25	777701382185	113.68
38224	3/4 x 24"	5/25	777701382246	118.24

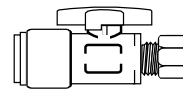

VALVES À BILLE DROITE 'PUSH-FIT' x O.D. CHROME				
#BMI	Taille	Emballage	Code-barres	\$
38984	1/2 x 3/8 (O.D.)	10/100	777701389849	51.80

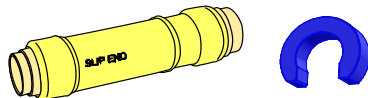

MANCHONS COULISSANT 'PUSH-FIT'				
#BMI	Taille	Emballage	Code-barres	\$
38014	1/2	10/50	777701380143	54.57
38015	3/4	5/30	777701380150	89.81
38016	1	5/25	777701380167	140.97

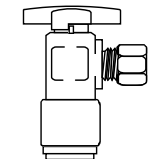

VALVES À BILLE ANGLE 'PUSH-FIT' x O.D. CHROME				
#BMI	Taille	Emballage	Code-barres	\$
38989	1/2 x 3/8 (O.D.)	10/100	777701389894	53.51

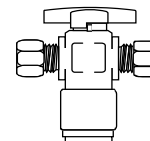

VALVES À BILLE ANGLE 'PUSH-FIT' x O.D. DOUBLE				
#BMI	Taille	Emballage	Code-barres	\$
38919	1/2 x 3/8 x 3/8 (O.D.)	10/100	777701389191	80.60

LISTE DE PRIX BMI CANADA MANCHONS EN ACIER OUVRÉ

MER
25-1

12 mars 2025

DEMI-MANCHONS EN ACIER OUVRÉ

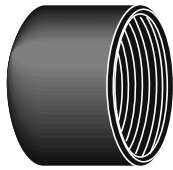

Filetage NPS

* = filetage NPT

#BMI	Taille	Emballage	Code à barres	\$
41201	1/8	100/1200	777701412011	3.06
41202	1/4	50/1200	777701412028	3.70
41203	3/8	50/1200	777701412035	4.10
41204	1/2	50/800	777701412042	4.38
41205	3/4	50/400	777701412059	6.01
41206	1	60/240	777701412066	9.19
41207	1 1/4	25/200	777701412073	11.11
41208	1 1/2	25/150	777701412080	14.25
41209	2	25/100	777701412097	19.36
* 41210	2 1/2	1/50	777701412103	57.71
* 41211	3	1/32	777701412110	90.00
* 41212	4	1/25	777701412127	122.27
* 41214	6	1/9	777701412141	322.23

MANCHONS EN ACIER OUVRÉ



Filetage NPS

* = filetage NPT

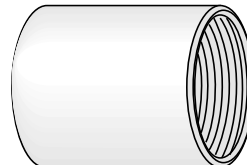

NOIRS				
#BMI	Taille	Emballage	Code à barres	\$
41001	1/8	10/600	777701410017	4.03
41002	1/4	10/500	777701410024	4.92
41003	3/8	10/300	777701410031	5.40
41004	1/2	10/250	777701410048	5.90
41005	3/4	50/200	777701410055	8.03
41006	1	30/120	777701410062	12.16
41007	1 1/4	10/70	777701410079	14.80
41008	1 1/2	10/60	777701410086	19.16
41009	2	18/36	777701410093	25.77
41010	2 1/2	1/32	777701410109	76.98
41011	3	1/6	777701410116	120.13
41012	4	1/4	777701410123	163.15
41013	5	1/5	777701410130	259.27
41014	6	1/3	777701410147	439.09

GALVANISÉS				
#BMI	Taille	Emballage	Code à barres	\$
41101	1/8	10/600	777701411014	4.10
41102	1/4	50/900	777701411021	5.23
41103	3/8	10/600	777701411038	5.70
41104	1/2	10/250	777701411045	6.35
41105	3/4	50/200	777701411052	8.68
41106	1	30/120	777701411069	13.37
41107	1 1/4	10/70	777701411076	16.29
41108	1 1/2	1/50	777701411083	20.98
41109	2	20/40	777701411090	28.91
* 41110	2 1/2	1/20	777701411106	83.17
* 41111	3	1/6	777701411113	130.03
* 41112	4	1/9	777701411120	176.61
* 41113	5	1/1	777701411137	284.36
* -	-	-	-	-



Vancouver ~ Toronto ~ Montreal

www.bmicanada.com



STN
25-1

12 mars 2025



1 800 361-1452



1 800 561-8579

LISTE DE PRIX BMI CANADA - MAMELONS DE TUYAU D'ACIER NOIR STANDARD

"ERW" MAMELON DE TUYAU D'ACIER NOIR-SOUDÉ
TUYAU D'ACIER SELON ASTM A-53-GRADE "A"

FILETAGE À DROITE

Diam.	Longueur		FILETAGE À DROITE																
	"Close"	"Close"	1 1/2"	2"	2 1/2"	3"	3 1/2"	4"	4 1/2"	5"	5 1/2"	6"	6 1/2"	7"	8"	9"	10"	11"	12"
1/8	3/4	8.61	8.89	9.26	10.39	10.93	12.00	12.28	14.04	14.39	15.09	16.58		17.74	18.79	19.80	20.93	21.87	23.46
# BMI		10100	10115	10120	10125	10130	10135	10140	10145	10150	10155	10160		10167	10168	10169	10170	10171	10172
1/4	7/8	7.63	7.84	8.27	9.44	9.93	10.63	11.14	14.80	15.78	16.03	16.54		17.20	18.29	19.22	20.38	21.34	22.67
# BMI		10200	10215	10220	10225	10230	10235	10240	10245	10250	10255	10260		10267	10268	10269	10270	10271	10272
3/8	1	7.68	8.00	8.51	9.52	10.21	11.14	12.28	15.05	15.89	16.43	17.72		18.51	19.76	20.85	22.24	23.43	24.60
# BMI		10300	10315	10320	10325	10330	10335	10340	10345	10350	10355	10360		10367	10368	10369	10370	10371	10372
1/2	1 1/8	4.50	4.67	5.10	5.36	5.91	6.87	7.21	8.00	8.51	9.07	9.52		17.35	19.22	21.10	21.73	22.90	24.40
# BMI		10400	10415	10420	10425	10430	10435	10440	10445	10450	10455	10460		10467	10468	10469	10470	10471	10472
3/4	1 3/8	5.50	5.75	5.91	6.10	6.92	7.68	8.18	8.99	9.52	10.40	11.48		21.73	22.68	24.28	25.49	27.31	29.34
# BMI		10500	10515	10520	10525	10530	10535	10540	10545	10550	10555	10560		10567	10568	10569	10570	10571	10572
1	1 1/2	8.18		8.99	9.52	10.01	11.08	12.00	13.14	14.04	14.86	15.57	18.79	27.55	29.14	32.11	33.72	35.78	37.59
# BMI		10600		10620	10625	10630	10635	10640	10645	10650	10655	10660	10665	10667	10668	10669	10670	10671	10672
1 1/4	1 5/8	10.28		11.27	11.50	12.81	14.04	15.09	16.09	17.37	18.39	19.45		33.19	35.44	38.60	41.12	44.08	45.94
# BMI		10700		10720	10725	10730	10735	10740	10745	10750	10755	10760		10767	10768	10769	10770	10771	10772
1 1/2	1 3/4	12.43		13.28	14.50	15.47	17.56	18.61	19.87	20.93	22.49	23.55		37.71	40.03	42.81	45.55	48.61	51.04
# BMI		10800		10820	10825	10830	10835	10840	10845	10850	10855	10860		10867	10868	10869	10870	10871	10872
2	2	16.03			17.74	19.30	21.72	23.72	25.47	27.38	29.70	31.67		45.26	51.56	55.35	59.27	65.52	69.92
# BMI		10900			10925	10930	10935	10940	10945	10950	10955	10960		10967	10968	10969	10970	10971	10972
2 1/2	2 1/2	59.44				62.20	68.58	71.16	76.09	80.64	85.87	90.45		92.84	94.94	104.08	113.68	123.33	132.63
# BMI		10001				10002	10003	10004	10005	10006	10007	10008		10009	10010	10011	10012	10013	10014
3	2 5/8	67.80				69.60	77.93	79.63	84.12	90.03	95.52	101.28		104.12	116.03	126.09	137.93	149.79	161.72
# BMI		10021				10022	10023	10024	10025	10026	10027	10028		10029	10030	10031	10032	10033	10034
4	2 7/8	101.64					110.66	115.23	121.76	131.89	142.26	152.72		168.67	187.50	206.04	224.49	243.32	262.19
# BMI		10041					10042	10043	10044	10045	10046	10047		10049	10050	10051	10052	10053	10054
6		436																	
# BMI		10082																	
		"Close"	1 1/2"	2"	2 1/2"	3"	3 1/2"	4"	4 1/2"	5"	5 1/2"	6"	6 1/2"	7"	8"	9"	10"	11"	12"



Vancouver ~ Toronto ~ Montreal

www.bmicanada.com



STN
25-1

12 mars 2025

1 800 361-1452



1 800 561-8579

MAMELONS DE TUYAU D'ACIER GALVANISÉ STANDARD

"ERW" MAMELONS DE TUYAU D'ACIER GALVANISÉ-SOUDÉ
TUYAU D'ACIER SELON ASTM A-53-GRADE "A"

FILETAGE À DROITE

Diam.	Longueur		FILETAGE À DROITE																
	"Close"	"Close"	1 1/2"	2"	2 1/2"	3"	3 1/2"	4"	4 1/2"	5"	5 1/2"	6"	7"	8"	9"	10"	11"	12"	
1/8	3/4	9.71	10.39	11.75	13.71	14.57	15.89	16.71	17.56	18.41	19.22	20.13						27.98	
# BMI		11100	11115	11120	11125	11130	11135	11140	11145	11150	11155	11160						11171	
1/4	7/8	8.51	9.07	9.71	11.08	11.75	12.81	14.04	15.89	17.27	18.41	19.30	20.66	22.09	23.71	25.00	26.94	28.36	
# BMI		11200	11215	11220	11225	11230	11235	11240	11245	11250	11255	11260	11267	11268	11269	11270	11271	11272	
3/8	1	8.79	9.26	9.93	11.47	12.04	13.22	14.44	16.79	18.79	19.47	20.38	21.48	22.90	24.80	26.66	28.07	29.93	
# BMI		11300	11315	11320	11325	11330	11335	11340	11345	11350	11355	11360	11367	11368	11369	11370	11371	11372	
1/2	1 1/8	5.60	5.91	6.48	7.08	7.68	8.61	9.44	10.01	10.77	11.75	12.47	22.09	25.49	26.50	27.55	29.93	31.70	
# BMI		11400	11415	11420	11425	11430	11435	11440	11445	11450	11455	11460	11467	11468	11469	11470	11471	11472	
3/4	1 3/8	6.87	7.08	7.36	8.18	9.07	10.28	11.27	12.25	13.22	14.27	15.47	28.68	31.72	33.40	33.72	36.04	40.03	
# BMI		11500	11515	11520	11525	11530	11535	11540	11545	11550	11555	11560	11567	11568	11569	11570	11571	11572	
1	1 1/2	10.20		11.08	12.03	13.09	14.44	15.79	17.05	18.27	19.20	20.34	34.94	37.71	41.56	44.89	47.43	49.67	
# BMI		11600		11620	11625	11630	11635	11640	11645	11650	11655	11660	11667	11668	11669	11670	11671	11672	
1 1/4	1 5/8	13.09		14.39	15.22	16.33	18.33	19.91	21.41	22.89	24.28	25.84	44.28	48.24	51.56	55.57	58.16	62.97	
# BMI		11700		11720	11725	11730	11735	11740	11745	11750	11755	11760	11767	11768	11769	11770	11771	11772	
1 1/2	1 3/4	15.89		16.79	18.33	19.58	21.87	23.99	25.98	27.87	29.70	31.00	48.04	53.14	57.24	61.23	64.19	68.57	
# BMI		11800		11820	11825	11830	11835	11840	11845	11850	11855	11860	11867	11868	11869	11870	11871	11872	
2	2	20.56			22.68	25.00	28.36	30.83	32.93	35.44	37.96	40.43	62.76	67.35	72.64	77.31	82.78	88.76	
# BMI		11900			11925	11930	11935	11940	11945	11950	11955	11960	11967	11968	11969	11970	11971	11972	
2 1/2	2 1/2	78.14				80.64	90.60	93.26	99.11	106.83	114.55	120.69	126.28	134.14	140.73	153.19	166.02	178.95	
# BMI		11001				11002	11003	11004	11005	11006	11007	11008	11009	11010	11011	11012	11013	11014	
3	2 5/8	92.46				94.94	106.33	109.05	116.02	123.80	131.62	139.45	151.04	160.64	177.15	194.14	210.20	226.95	
# BMI		11021				11022	11023	11024	11025	11026	11027	11028	11029	11030	11031	11032	11033	11034	
4	2 7/8	137.74					149.96	153.53	165.73	179.61	194.14	208.11	233.81	260.87	286.05	312.41		364.32	
# BMI		11041					11042	11043	11044	11045	11046	11047	11049	11050	11051	11052		11054	
		"Close"	1 1/2"	2"	2 1/2"	3"	3 1/2"	4"	4 1/2"	5"	5 1/2"	6"	7"	8"	9"	10"	11"	12"	



Vancouver ~ Toronto ~ Montreal

www.bmicanada.com



STN
25-1

12 mars 2025



1 800 361-1452



1 800 561-8579

EMBALLAGES PAR SAC ET PAR BOÎTE

CES EMBALLAGES SONT APPLICABLES POUR LES MAMELONS DE TUYAU D'ACIER SOUDÉ NOIR ET GALVANISÉ

Diam.	Emballage	"Close"	1 1/2"	2"	2 1/2"	3"	3 1/2"	4"	4 1/2"	5"	5 1/2"	6"	6 1/2"	7"	8"	9"	10"	11"	12"
1/8	Sac	25	25	25	25	25	25	25	25	25	25	25		25	25	25	25	25	25
	Boîte	400	400	400	400	400	400	400	400	400	400	400		400	400	200	200	200	200
1/4	Sac	25	25	25	25	25	25	25	25	25	25	25		25	25	25	25	25	25
	Boîte	400	400	400	400	400	400	400	400	400	400	400		200	200	200	200	200	200
3/8	Sac	25	25	25	25	25	25	25	25	25	25	25		25	25	25	25	25	25
	Boîte	400	400	400	400	400	400	400	400	300	300	300		150	150	100	100	100	100
1/2	Sac	25	25	25	25	25	25	25	25	25	25	25		25	25	25	25	25	25
	Boîte	400	400	400	300	300	300	200	200	200	200	200		100	100	100	100	100	100
3/4	Sac	25	25	25	25	25	25	25	25	25	25	25		25	25	25	25	25	25
	Boîte	400	400	300	300	200	200	150	150	100	100	100		75	75	50	50	50	50
1	Sac	25		25	25	25	25	25	25	25	25	25	25	25	25	25	20	20	20
	Boîte	200		200	150	150	100	100	100	75	75	50	50	50	50	50	40	40	40
1 1/4	Sac	25		25	25	25	25	25	25	25	25	25		15	15	15	1	1	1
	Boîte	100		100	100	100	50	50	50	50	50	50		30	30	30	30	30	30
1 1/2	Sac	25		25	25	25	25	25	25	20	20	20		1	1	1	1	1	1
	Boîte	100		100	50	50	50	50	50	40	40	40		35	25	25	15	15	15
2	Sac	25			25	1	1	1	1	1	1	1		1	1	1	1	1	1
	Boîte	50			50	50	25	25	25	25	25	25		18	18	18	14	14	14
2 1/2	Sac	1				1	1	1	1	1	1	1		1	1	1	1	1	1
	Boîte	36				36	27	27	24	18	18	18		14	12	12	9	9	9
3	Sac	1				1	1	1	1	1	1	1		1	1	1	1	1	1
	Boîte	24				24	18	18	16	12	12	12		9	8	8	6	6	6
4	Sac	1				1	1	1	1	1	1	1		1	1	1	1	1	1
	Boîte	15				12	12	10	8	8	8	8		5	5	5	4	4	4
		"Close"	1 1/2"	2"	2 1/2"	3"	3 1/2"	4"	4 1/2"	5"	5 1/2"	6"	6 1/2"	7"	8"	9"	10"	11"	12"



Vancouver ~ Toronto ~ Montreal

www.bmicanada.com



**STN
25-1**

1 800 361-1452

1 800 561-8579

12 mars 2025

TUYAUX PRÉ-COUPÉS FILETÉS NOIRS

Fileté aux deux extrémités (protection avec capuchon de plastique)

Diamètre / Longueurs	13"	14"	15"	16"	17"	18"	19"	20"	21"	24"	30"	36"	48"	60"	72"	pièces / paquet
1/2	-	31.46	-	-		36.12	-	-	-	44.83	56.10	67.23	89.49	111.93	127.50	5
# BMI	-	10473	-	-		10478	-	-	-	10479	10480	10481	10483	10485	10487	
3/4	-	-	-	41.52		45.09	-	-	-	54.24	67.49	81.01	107.99	134.68	153.31	5
# BMI	-	-	-	10576		10578	-	-	-	10579	10580	10581	10583	10585	10587	
1	39.82	57.69	42.31	66.53	71.95	63.19	56.08	56.92	61.52	76.33	90.20	105.01	138.07	172.45	206.04	3
# BMI	10677	10673	10682	10674	10684	10678	10686	10692	10693	10679	10680	10681	10683	10685	10687	
1 1/4	-	-	-	-		79.34	-	-	-	100.49	131.94	158.32	200.97	246.72	272.60	3
# BMI	-	-	-	-		10778	-	-	-	10779	10780	10781	10783	10785	10787	
1 1/2	-	-	-	-		87.60	-	-	-	116.59	138.26	161.78	205.03	250.92	320.66	3
# BMI	-	-	-	-		10878	-	-	-	10879	10880	10881	10883	10885	10887	
2	-	112.59	-	101.89		119.84	-	-	-	157.29	186.41	217.25	275.35	336.46	426.46	3
# BMI	-	10974	-	10976		10978	-	-	-	10979	10980	10981	10983	10985	10987	
3										403.23						3
# BMI										10020						
4	-					538.53										2
# BMI	-					10055										

TUYAUX PRÉ-COUPÉS FILETÉS GALVANISÉS

Fileté aux deux extrémités (protection avec capuchon de plastique)

Diamètre / Longueurs	13"	14"	15"	16"	17"	18"	19"	20"	21"	24"	30"	36"	48"	60"	72"	pièces / paquet
1/2	-	-	-	-		44.93	-	-	-	59.15	73.80	88.36	117.99	147.53	168.10	5
# BMI	-	-	-	-		11478	-	-	-	11479	11480	11481	11483	11485	11487	
3/4	-	-	-	-		56.80	-	-	-	75.00	93.71	112.54	149.82	187.15	213.17	5
# BMI	-	-	-	-		11578	-	-	-	11579	11580	11581	11583	11585	11587	
1	-	-	-	-		80.34	-	-	-	100.05	119.84	141.04	185.76	232.25	263.87	3
# BMI	-	-	-	-		11678	-	-	-	11679	11680	11681	11683	11685	11687	
1 1/4	-	-	-	-		106.94	-	-	-	132.68	159.11	187.53	240.74	296.52	347.48	3
# BMI	-	-	-	-		11778	-	-	-	11779	11780	11781	11783	11785	11787	
1 1/2	-	-	-	-		120.00	-	-	-	154.95	186.47	220.48	283.91	349.91	410.09	3
# BMI	-	-	-	-		11878	-	-	-	11879	11880	11881	11883	11885	11887	
2	-	-	-	-		155.34	-	-	-	207.24	253.04	298.26	383.19	471.93	552.10	3
# BMI	-	-	-	-		11978	-	-	-	11979	11980	11981	11983	11985	11987	
2 1/2	-					419.68										3
# BMI	-					11015										
3						455.47										3
# BMI						11035										
4	-									748.72		898.37				2
# BMI	-									11056		11058				
6	-					1747.29										1
# BMI	-					11090										

**ASSORTIMENTS SIMPLES**

UN (1) DE CHAQUE LONGUEUR "CLOSE" À 6"

# BMI		Diam.	Ttl mcx / boite	lbs / boite	\$	
NOIR	GALV.				NOIR	GALV.
10489		1/2	11	2.5	89.52	
10589	11589	3/4	11	3.5	97.56	340.55
10689	11689	1	10	5	124.71	471.62
10789		1 1/4	10	7	245.25	
10889		1 1/2	10	8	294.36	
10989		2	9	10	365.46	

ASSORTIMENTS DE SIX

(6) DE CHAQUE LONGUEUR "CLOSE" À 6"

# BMI		Diam.	Ttl mcx / boite	lbs / boite	\$	
NOIR	GALV.				NOIR	GALV.
10490		1/2	66	17	713.37	
10590		3/4	66	19	876.78	
10690		1	60	27	989.12	



Vancouver ~ Toronto ~ Montreal

www.bmicanada.com



1 800 361-1452



1 800 561-8579

LISTE DE PRIX BMI CANADA - MAMELONS DE TUYAU D'ACIER NOIR EXTRALOURDS SANS SOUDURE

**STX
25-1**

12 mars 2025

MAMELON DE TUYAU D'ACIER SCH. 80
TUYAU D'ACIER SANS SOUDURE SELON ASTM A-106-GRADE "B"

FILETAGE À DROITE

Diam.	Longueur															
	"Close"	"Close"	1 1/2"	2"	2 1/2"	3"	3 1/2"	4"	4 1/2"	5"	5 1/2"	6"	7"	12"	14"	18"
1/8	3/4			15.57							24.89					
BMI #				12120							12155					
1/4	7/8	9.07	9.35	9.92	10.39	11.14	12.28	13.14	14.46	15.89	17.24	18.39				
BMI #		12200	12215	12220	12225	12230	12235	12240	12245	12250	12255	12260				
3/8	1	10.09	10.20	10.90	11.48	12.28	13.53	14.96	16.79	18.20	19.80	20.72				
BMI #		12300	12315	12320	12325	12330	12335	12340	12345	12350	12355	12360				
1/2	1 1/8	9.34	9.93	10.61	11.48	12.04	13.61	14.87	16.09	17.24	18.32	19.22				
BMI #		12400	12415	12420	12425	12430	12435	12440	12445	12450	12455	12460				
3/4	1 3/8	11.47	11.65	12.35	12.95	13.92	15.44	16.49	17.77	19.13	20.38	21.73				43.30
BMI #		12500	12515	12520	12525	12530	12535	12540	12545	12550	12555	12560				12578
1	1 1/2	17.16		18.41	19.75	20.83	22.70	24.07	25.84	27.17	28.76	30.67				
BMI #		12600		12620	12625	12630	12635	12640	12645	12650	12655	12660				
1 1/4	1 5/8	21.22		22.59	24.28	25.84	28.40	30.67	32.63	34.62	36.46	38.60				
BMI #		12700		12720	12725	12730	12735	12740	12745	12750	12755	12760				
1 1/2	1 3/4	24.89		26.42	28.68	30.48	33.77	36.72	38.38	40.97	43.20	45.76				
BMI #		12800		12820	12825	12830	12835	12840	12845	12850	12855	12860				
2	2	33.17			36.46	39.65	44.12	47.54	51.17	54.98	58.26	61.62	74.80	117.76	134.58	
BMI #		12900			12925	12930	12935	12940	12945	12950	12955	12960	12967	12972	12974	
2 1/2	2 1/2	100.11				104.08		120.43	127.12	135.50		152.23				
BMI #		12001				12002		12004	12005	12006		12008				
3	2 5/8	112.41					127.90	131.26	138.75	147.93		166.23		250.00		
BMI #		12021					12023	12024	12025	12026		12028		12034		
4	2 7/8											248.91				
BMI #												12047				
	"Close"	1 1/2"	2"	2 1/2"	3"	3 1/2"	4"	4 1/2"	5"	5 1/2"	6"	7"	12"	14"	18"	



Membre
platine

Boisbriand, le 1^{er} janvier 2026

À TOUS NOS CLIENTS

Objet : Politique de retour BMI

BMI répond aux besoins de ses clients en leur fournissant des produits en quantités spécifiques différentes de l'emballage d'origine, lorsque cela est nécessaire. Cependant, afin de préserver l'intégrité et la qualité de ses produits, BMI n'acceptera aucun retour de marchandise autre que dans l'emballage d'origine (emballage intérieur/en gros ou Inner/Master).

Tout produit retourné est inspecté et assujéti à des frais de manutention. Tout retour doit être approuvé au préalable et être accompagné d'un numéro d'autorisation de retour (RGA).

Les produits retournés doivent être expédiés port payé, avoir été fournis par BMI, être courants, en parfaite condition et en quantité raisonnable par rapport à la demande du marché actuel.

En raison des coûts de traitement des retours, BMI n'acceptera plus les demandes de retour inférieures à 100,00 \$.

Merci pour votre compréhension à cet égard.

Meilleures salutations,

Garth Anderson
Vice-président aux ventes